

# Research & Development

Research and Development

## Low-temperature Poly-Si TFT Formation Technology for System-in-display

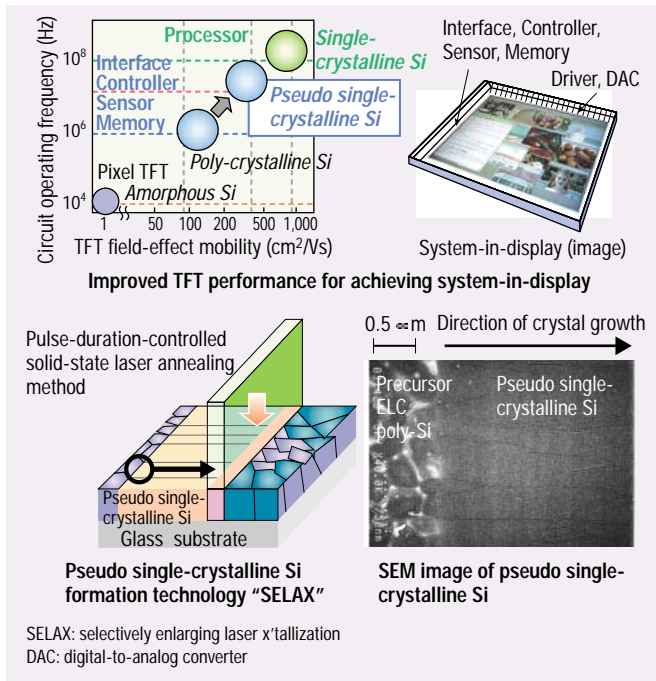

A low-temperature poly-Si TFT (thin film transistor) has been developed for the next-generation mobile display, the "system-in-display." The active layer of the TFT consists of high-quality pseudo single-crystalline Si instead of conventional polycrystalline Si. This gives the TFT both high and uniform performance. The TFT has high field-effect mobility ( $\mu > 450 \text{ cm}^2/\text{Vs}$ ) and low deviation (to 1/4 of previous levels). This high-performance TFT enables integration of functional circuits, such as interfaces, controllers, sensors, and memories on glass.

A novel crystallization method called "SELAX" to obtain the pseudo single-crystalline Si. In this method, pulse-duration-controlled solid-state laser annealing is used to enlarge the Si grains and to control their location. The SELAX process is highly compatible with conventional low-temperature poly-Si TFT processes and can be further adapted for production on large glass panels.

Low-temperature poly-Si TFT formation technology for system-in-display

## 280-fs World's Fastest 20-nm-gate-length CMOS Device

—One-order reduction in leakage current with a nitride-based gate insulator—

A 20-nm-gate-length CMOS (complementary metal-oxide semiconductor) device suitable for high-speed, low-power applications has been developed.

CMOS devices used in system LSIs reduce the gate length and thin the gate-insulation film. However, while thinning the insulation film does increase speed, it also reduces its effectiveness as an insulator, leading to greater power consumption due to leakage current. A CMOS device is thus needed that increases the speed without increasing the gate leakage current.

We have used an offset-spacer structure to reduce gate capacitance, resulting in high-speed operation. The measured speed of a 20-nm-gate-length CMOS device was 280 fs, the fastest speed reported so far. The gate leakage current was reduced to less than one order of magnitude compared to that of conventional gate dielectrics by using a nitride-based gate insulation film.

This device will help bring about a next-generation high-speed low-power CMOS that will expand the mobile equipment market.

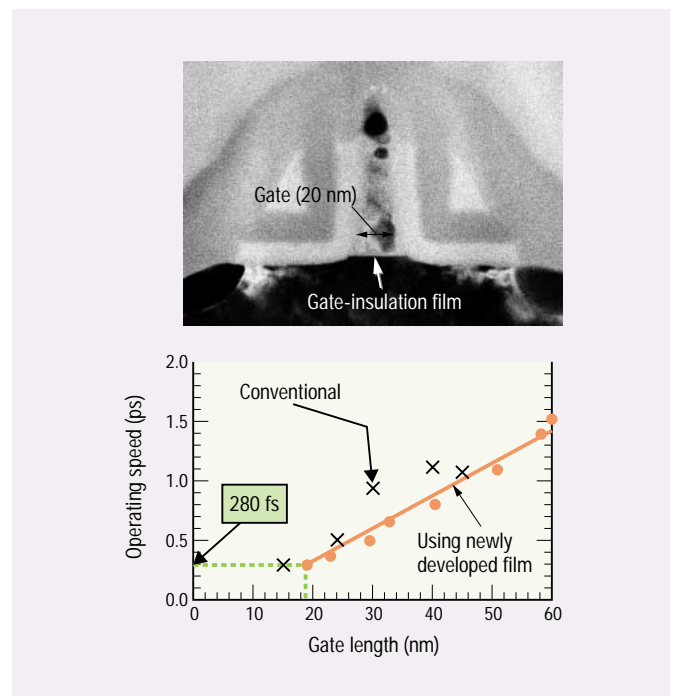

Cross section of 20-nm-gate-length CMOS device (TEM image) (top) and CMOS device (NMOS) operating speed (bottom)

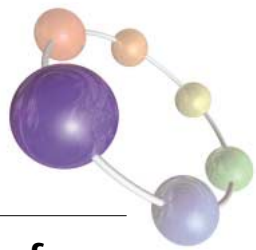

## Perpendicular Recording Heads for Areal Densities of over 100 Gbit/in<sup>2</sup>

Perpendicular recording heads enable 100 Gbit (billion bits) in a square-inch (25 x 25 mm) area, enabling high capacity in compact hard disk drives.

Perpendicular recording has great potential for next-generation recording with areal densities of over 100 Gbit/in<sup>2</sup>. We fabricated narrow track write heads with a pole width of 140 nm to achieve high areal density. A big problem with narrow-track writing is head-induced data erasure. We have developed a new technique for stabilizing magnetic domains in the pole tip to solve this problem. We also developed highly sensitive tunneling magnetoresistive (TMR) sensors suitable as next-generation read heads. We obtained high sensitivity with a narrow-track TMR head fabricated using electron beam lithography.

This technique should enable recording of over 100 Gbit/in<sup>2</sup> on hard disk drives and the recording of three movie films or 170 hours of music in the area of one square inch.

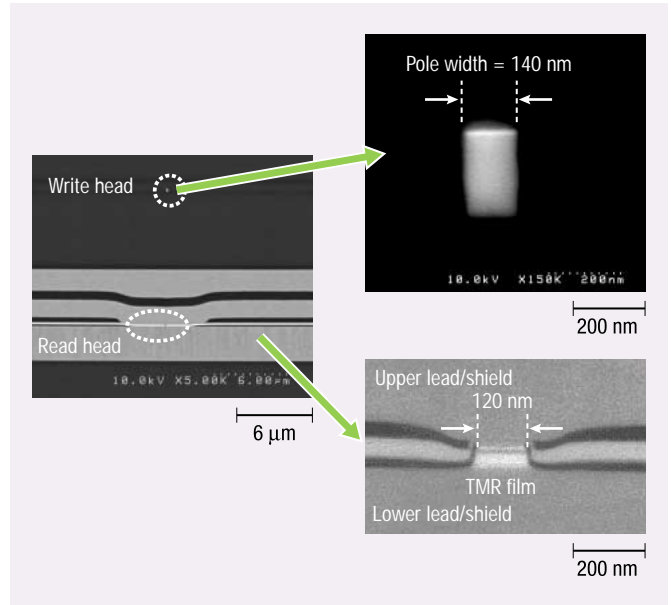

SEM (scanning electron microscope) images of fabricated head observed from air-bearing surface



## Scaled SiGe HBT and Logic IC with 80-GHz Operating Clock

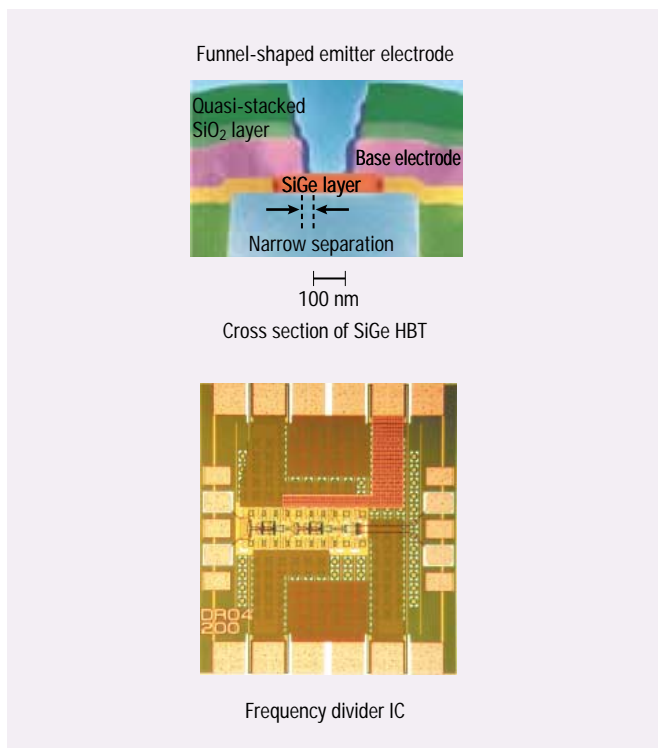

Cross section of SiGe HBT and frequency divider IC

Ultra-high-speed transistors are essential for optical communications at 40 Gbit/s and for microwave/millimeter-wave wireless communications on wide-bandwidth radio links at about 5 to 60 GHz. Improvement in transistor performance, especially increasing the operating speed and reducing the power consumption by applying scaled-down dimensions, is very important for these applications. Hitachi has developed a self-aligned selective-epitaxial-growth SiGe heterojunction bipolar transistor (HBT) with a funnel-shaped emitter electrode and a narrow separation between the emitter and base electrodes that is structurally optimized for an emitter scaled-down towards 100 nm. The former is effective for suppressing the increase in the emitter resistance of the scaled-down emitter, while the latter reduces the base resistance. This SiGe HBT has ultra-high-speed performance, a peak cutoff frequency of 141 GHz, and an ECL (emitter-coupled logic) gate delay of 4.9 ps. Hitachi has also developed a static frequency divider with a maximum operating frequency of 81 GHz.

These device technologies should play a key role in future large-capacity communication systems and pave the way for the development of next-generation optical-fiber-link LSIs and millimeter-wave wireless-communication ICs.

## Detection of Brain Neural Activity Due to Dizzy Sensation

A magnetoencephalogram (MEG) system using a SQUID (superconducting quantum interference device) has been developed for measuring the very low magnetic field created by brain neural activity. The system uses superconducting fabrication technology and a new visualization technique that make it possible to understand the brain's electrical network.

Dizziness, i.e. a floating sensation, is a common complaint of elderly people. However, the mechanism is not well understood due to the lack of a tool for measuring the sensation. Using our MEG system, we detected an abnormal neural network creating a dizzy sensation in the brain. We determined that the auditory network in patients who experienced dizzy sensations had a spread activated region, while that in normal patients had one activated region (see figure).

Use of our MEG system will provide new information about the brain's electrical network in patients with unidentified brain disorders. The information could give us a strategy for treatment and rehabilitation.

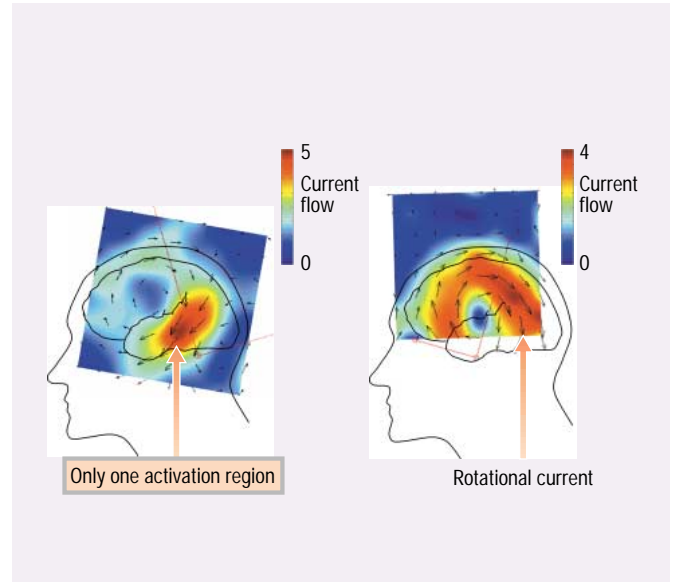

Dizzy-patient pattern (right) has a rotational current distribution, while non-dizziness-patient pattern (left) has one activation region.

## Next-generation Large-scale Simulation Technique for Grid-computing Environments

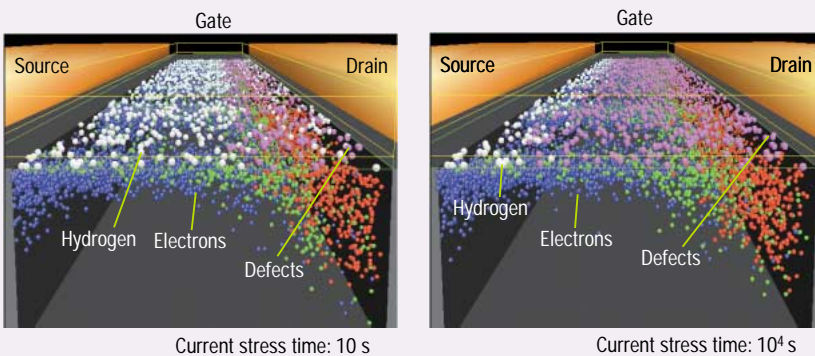

Time dependence of defect generation on current stress time

This study was supported as part of the Real World Computing (RWC) Project of the Ministry of Economy, Trade and Industry, and as part of the Research and Development Applying Computational Science and Technology (ACT) Project of the Japan Science and Technology Corporation (JST).

A next-generation simulation technique has been developed that enables various large-scale scientific simulations to be coupled with each other and executed simultaneously over networks. The middleware system automatically transfers and transforms physical values between simulation programs in the form of mediators, enabling users to efficiently hybridize scientific simulations on different spatial and temporal scales. The figure shows a multi-scale simulation of Si devices, in which lattice Monte Carlo (LMC) simulation is coupled with device Monte Carlo (DMC) simulation. Hydrogen desorption leading to defects is analyzed using LMC simulation, in which desorption takes longer than 1 s. High-energy electrons, which interact with hydrogen atoms and propagate along a short gate for  $10^{-12}$  s, are evaluated using DMC simulation. Coupled simulation in the form of mediators can be used to analyze the time dependence of defect generation after lengthy current stress. The middleware system will play a key role in multi-scale simulation in grid-computing environments using advanced programs developed in laboratories worldwide.

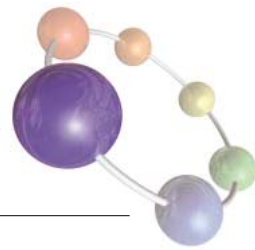

## Application of Friction Stir Welding

Friction stir welding (FSW) is a thermomechanical process in which materials are welded in the solid state (a). The use of FSW results in (1) very low distortion due to welding, (2) clean joints with excellent mechanical properties, and (3) reduced consumption (b). Hitachi holds a license to use FSW and has applied this process to commercial production of, for example, railway cars. Hitachi has also developed various types of FSW machines that are capable of welding 1-, 2-, and 3-dimensional shapes. Since 2001, these machines have been sold through Hitachi High-Technologies Corporation. Hitachi is a leader in this field.

In the 3-D machine (c), the welding head is numerically controlled as it moves along the welding line; the control data are automatically generated based on the computer-aided design data of the parts being welded.

Combining FSW with a robot (c) enables us to weld parts with various shapes into various configurations.

Hitachi will continue developing FSW techniques and equipment to meet the needs of many product fields, e.g. automobiles, ships, electro-devices, and aircraft.

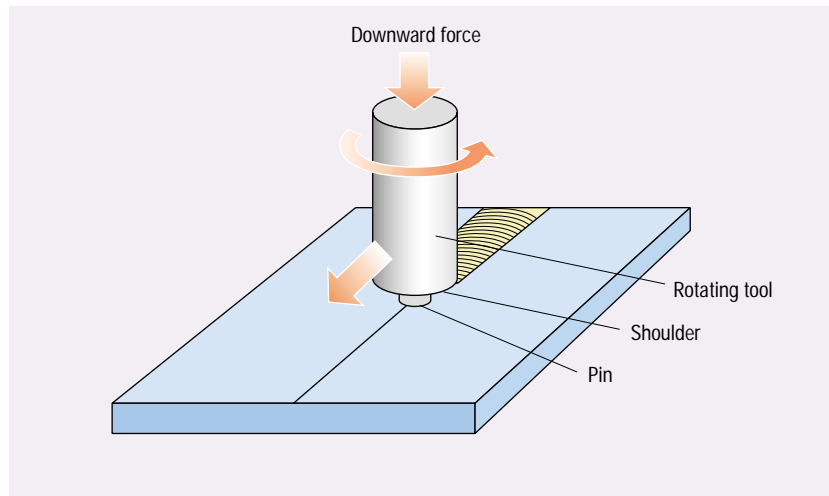

(a) Schematic arrangements illustrating friction stir welding

<p>Very low distortion</p> <ul style="list-style-type: none"> <li>• Good dimensional stability and repeatability</li> </ul>
<p>Improved material utilization</p> <ul style="list-style-type: none"> <li>• Al, Mg, Cu, steel, MMC (metal matrix composites), castings, extrusions, sheets...</li> <li>• Dissimilar materials</li> </ul>
<p>Fully mechanical process</p> <ul style="list-style-type: none"> <li>• No fumes, porosities, or spatters</li> </ul>
<p>Excellent mechanical/metallurgical properties</p>
<p>Very cost effective</p>

(b) Low distortion in friction stir welded plate (top) and features of friction stir welding (bottom)



(c) 3-D FSW machine (left) and FSW robot (right)

# High-power Lithium Ion Batteries for Electric Vehicles

Worldwide demands for energy savings and environmental conservation require new powering systems for vehicles to enhance their energy efficiency and reduce exhausted waste gases. Two alternatives are electric vehicles (EVs) driven by an electric motor and hybrid electric vehicles (HEVs) operated by a gasoline engine and an electric motor.

Both approaches require the use of secondary batteries. Lithium ion batteries (LIBs) have a higher operation voltage and a higher energy density (both in mass and volume) than other secondary batteries. They thus enable small and light powering systems, suitable for EVs and HEVs.

We have developed three types of LIB modules (see figures below). One is for EVs, which need higher electrical capacity for longer driving distances. Another is for HEVs, which need higher input-output power to assist the engine and yield electrical energy from the engine during braking. The third is for a new concept motorcycle, which needs both high capacity and sufficient power for good acceleration and driving distance.

The module for EVs is composed of 8 LIB cells connected serially and has a nominal voltage of 30 V and a rated capacity of 90 Ah. It is 290 mm wide, 440 mm long, and 186 mm high and weighs 29

kg. The energy density is 93 W/kg, and the power density is 350 W/kg.

The module for HEVs is composed of 48 LIB cells connected serially and has a nominal voltage of 170 V and a rated capacity of 3.6 Ah. It is 260 mm wide, 540 mm long, and 160 mm high, and weighs 20 kg. The rated output power is 12.5 kW, and the rated input power is 8.0 kW.

The module for motorcycles is composed of two sets of LIB cells. Each set has 7 cells connected serially, and the two sets are connected in parallel. The nominal voltage is 25 V, and the rated capacity is 14 Ah. The module is 87 mm wide, 144 mm long, and 372 mm high and weighs 6 kg. It can drive a 44-kg (including battery module) motorcycle 30 km on one full charge.

We developed new cathode material, anode material, and electrolyte for these modules that improve performance, safety, and reliability. For example, the use of lithium manganese oxide as the cathode material improves safety. The use of a new electrolyte improves the low-temperature discharge rate and output power. We will continue researching and developing novel materials to improve LIB performances.

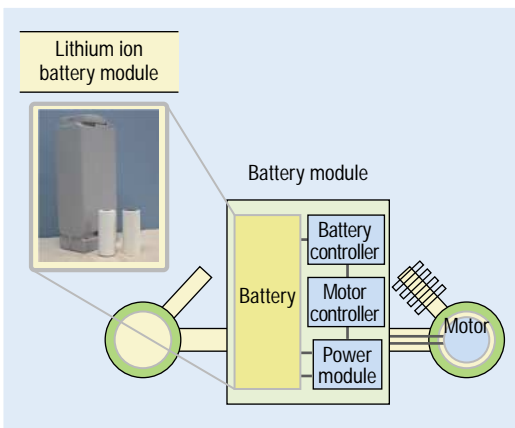

System diagram and lithium ion battery module for the motorcycles

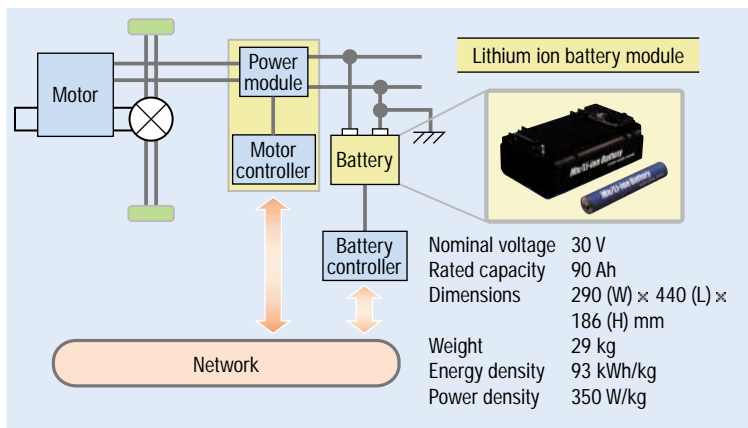

System diagram and lithium ion battery module for EVs

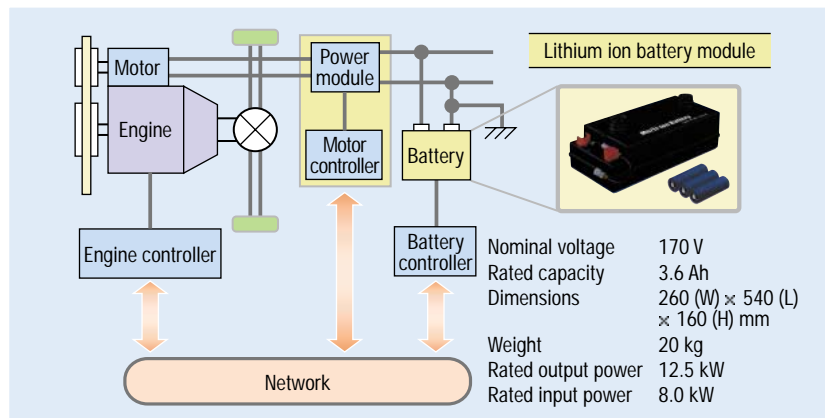

System diagram and lithium ion battery module for HEVs

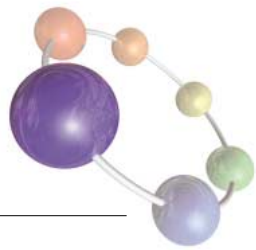

## B2B Telematic Services

Hitachi has been preparing telematic services for B2B (business to business) fields for several years with the following two services going to be launched soon. The first is the "safe driving diagnosis and support system," which is based on Hitachi's fleet management system in partnership of SOMPO JAPAN INSURANCE INC.'s diagnostic know-how and Hitachi's ITS technology. The system stores drivers' attitude to factors such as driving speed, acceleration, deceleration, time of continuous driving, and running routes in in-vehicle units and uploads the data to the fleet management ASP (application service provider) center through cellular-phone networks. This information is automatically analyzed by driving diagnosis software, which is a result of collaboration between Hitachi and SOMPO JAPAN. The diagnostic results are used to give effective suggestions to fleet drivers and managers to improve safe and cost effective driving. This may lead to a reduction in traffic accidents and fuel consumption, which would be economically beneficial to fleet companies.

A preliminary field trial shows that fuel consumption can be reduced by about 10 percent and excessive speeding can be avoided.

This service is going to launch in April 2003.

The second service Hitachi is preparing is a traffic information provision service for the B2B market. This is shown in the figure (top). In 2002, road traffic law changed so as to allow private companies to run traffic information provision services. Vehicle information and communication system (VICS) digital information is now available, not only for usual car-navigation use, but also for other services.

Value-added services such as traffic congestion forecasting are now possible. Hitachi is considering VICS based traffic information provision to fleet management systems and other B2B markets. Together with VICS information, so-called "probe-car information" based on fleet vehicles will soon be used. Probe cars are the vehicles which gather traffic information based on data such as GPS location data, which is readily available from the fleet management systems. The figures (bottom) show examples of probe data and the corresponding traffic congestion map of the Tokyo metropolitan area for fleet tracking.

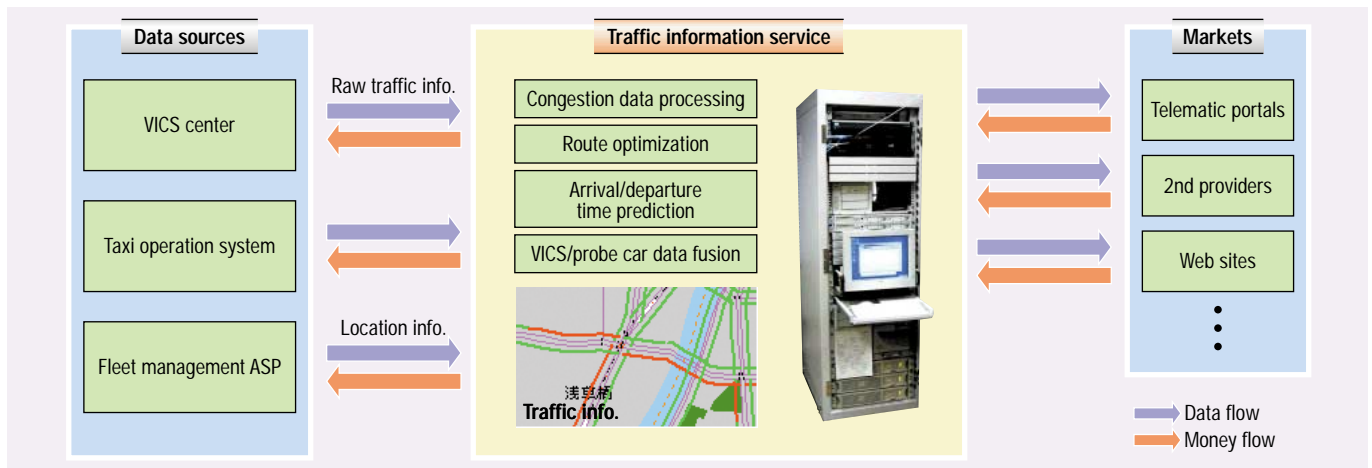

Traffic information provision service

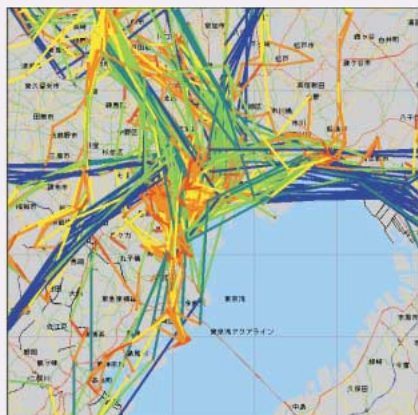

(a)



(b)

Typical probe car data (a) and congestion map obtained from the probe car data (b)

# Knowledge-based Engineering

A knowledge-based engineering (KBE) system has been developed to support designers. The system gathers and systematizes knowledge such as know-how and techniques used in the development and design processes. The developed system makes it possible to share knowledge among designers and collaborate at various locations and to hand down knowledge to the next generation. Furthermore, design can be speeded up and higher technology of product development can be accomplished by front-loading the design process using virtual prototyping with high-performance computer-aided engineering (CAE) tools.

The KBE system consists of three subsystems as a basic framework: (1) a knowledge database that stores the knowledge needed for development and design, (2) CAE tools combined with CAD for achieving virtual prototyping, and (3) a design/CAE navigator that

provides designers with the correct procedure, the necessary knowledge, and the appropriate CAE tools based on standardization of the design process. The CAE tools, such as an automatic brick mesh generator and an automatic mid-surface generator, reduce the time for analytic modeling, which accounts for more than 80% of the analysis task. The design/CAE navigator helps expertise to achieve popularization and reduction of their tasks in designing and analyzing process.

Application of this system to the design of air conditioners, refrigerators, hard disk drives, elevators, pump systems, etc. has led to improvements in product performance and reductions in development cycle times and costs. The system can reduce the development cycle time by up to 50%.

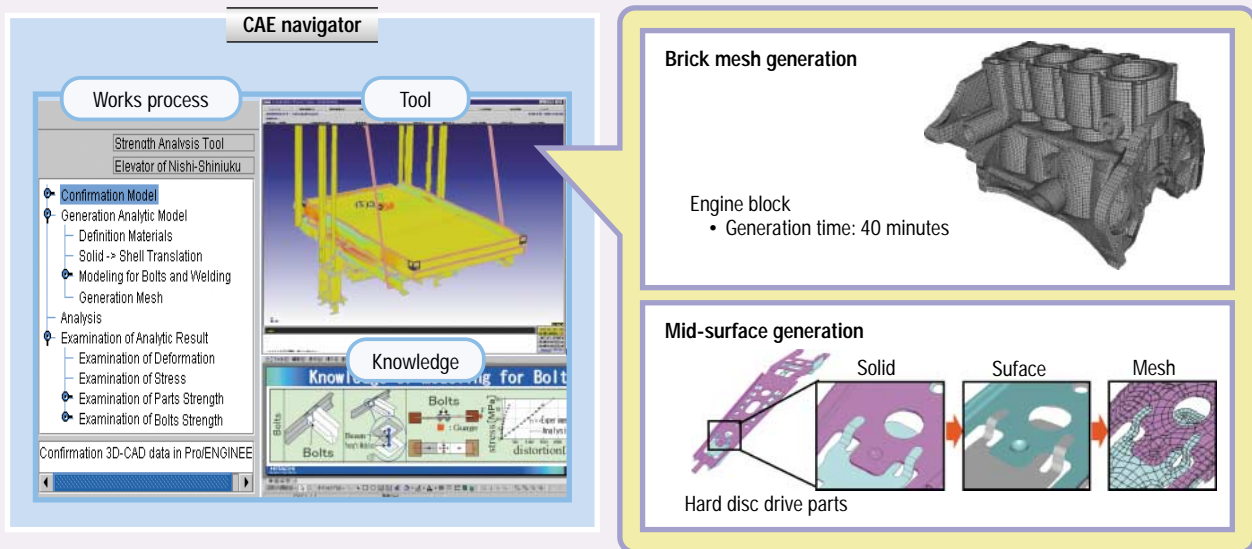

Design/CAE navigator and CAE tools

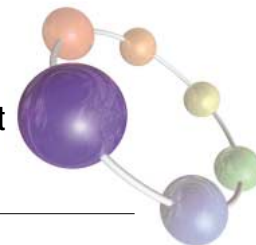

## Worldwide Banknotes Handling Technology

Hitachi's HT-2845 automated teller machine (ATM) is the first ATM that can both dispense and deposit worldwide banknotes. The key features are banknote validation and a banknote handling mechanism that can handle various-size banknotes.

The banknote handling mechanism can recycle various-size banknotes due to the use of an original cash box and a unique stacking mechanism. Banknotes are fed out from the cash box without the problem of "double-feeding," because the cash box stacks them in the standing position so that they are aligned with the bottom of the box. The unique stacking mechanism consists of a drum, a reel, and a tape between the drum and the reel; it uses tape winding and rewinding to stack and feed the banknotes.

The banknote handling mechanism is implemented in the cash module of the HT-2845 ATM; it is also being exported as an OEM product to the U.S. and Europe.

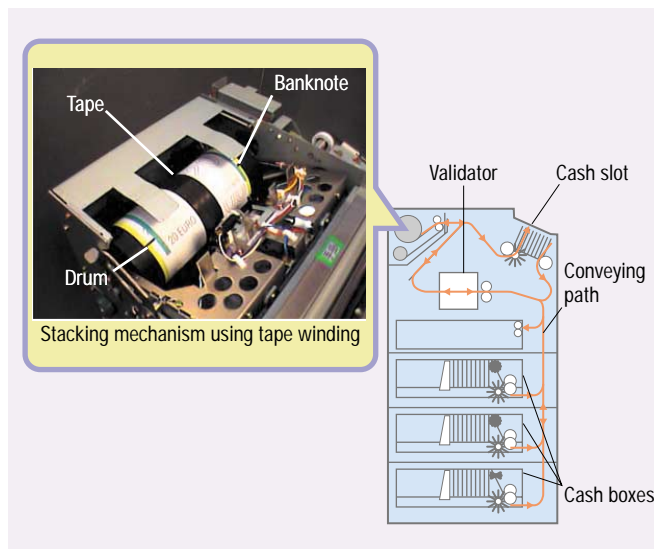

Cash module of Hitachi's HT-2845 ATM

## Micro-reactors for Chemical Processing System

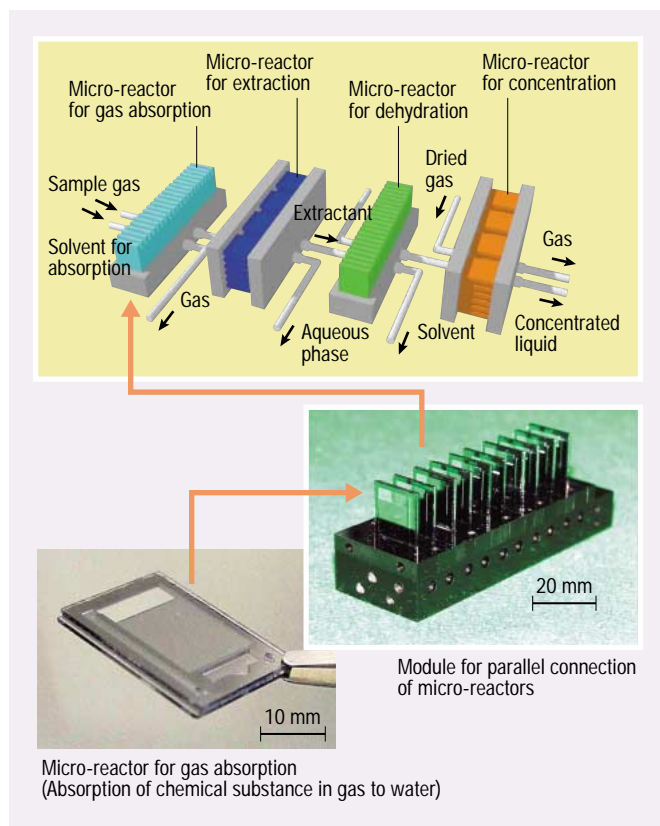

Chemical processing system composed of micro-reactors

Micro-reactors are minute fluid devices for controlling chemical reactions in reaction channels shorter than 100  $\mu\text{m}$ . Use of these devices should improve reaction rate due to the size effect, enabling heretofore impossible chemical processes to be achieved. We are studying the application of these devices to portable environmental analysis apparatuses, the manufacturing of specialty products, and so on.

We have developed a reactor for extracting chemical substances from gases and solvents and for condensing them at high speed. Use of this device will automate and improve the efficiency of chemical analyses requiring complex preprocessing. In addition, the amount of processing can be increased by connecting two devices in parallel.

This work was performed by Hitachi, Ltd. under the management of the Micromachine Center as a part of the Research and Development of Micromachine Technology supported by the New Energy and Industrial Technology Development Organization. We thank these agencies for their support of this research.

## Molecular-dynamics Technique for Determining Adhesive Strength of Interfaces Between Nanometer-thick Films

Highly integrated semiconductor devices and magnetoresistive heads are made up of thin-film layers of various materials, and the thickness of each film is gradually being reduced to within a few nanometers. Atomic diffusion is especially active near the interfaces between thin films of different materials and can lead to delamination and voids, which degrade device reliability. We have developed a molecular-dynamics technique for determining the adhesive strength of the interfaces between nanometer-thick films. It uses the extended Tersoff potential, which enables the delamination energy of metal/dielectric films, as well as of metal/metal films, to be calculated. It was used to calculate the delamination energy of the interfaces between ULSI-interconnect materials (Al and Cu) and diffusion-barrier materials (TiN and W). The calculated energies agreed well with those measured by scratch testing. The order of the energies, starting with the highest, was Al/TiN, Al/W, Cu/W, and Cu/TiN (see figure). This molecular-dynamics technique should thus be effective for predicting adhesive strength of interfaces.

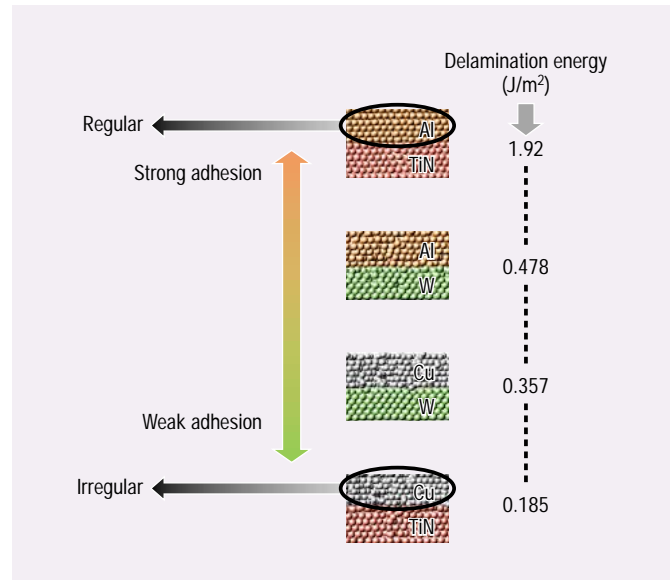

Relationship between delamination energy and configuration regularity obtained from molecular dynamics

## Mobile P2P and Web Services

Various research and development activities are in progress to enable the computers and the services provided in a computer network much more easily and efficiently. "Web services" and "peer-to-peer (P2P) networks" are of particular interest. Web services is the standard for computers to communicate with services in a network, and a P2P network is one in which computers (peers) communicate with each other directly to cooperate.

In addition, wireless-LAN access services in public spaces, such as airports, railway stations, and Internet cafés, are being implemented. And PDAs that can connect to wireless LANs are now on the market.

Brand-new solutions and services can be provided in this ubiquitous network by developing mobile devices, such as PDAs and cellular phones, etc. that support Web services and function as peers in P2P network. We have been developing P2P platform technologies that will enable mobile devices to serve as the base for these solutions and services. We are also researching P2P-based applications that support the activities of communities by extending the concept of P2P communication to "people's communication."

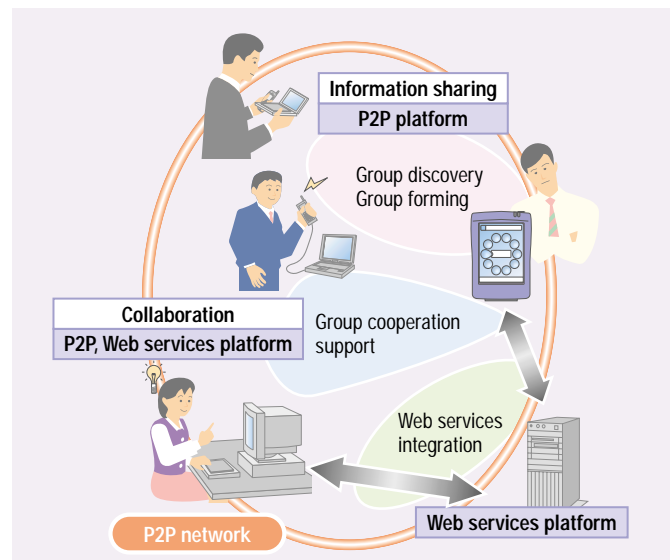

P2P-based community computing

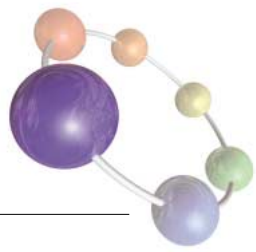

## Web Traffic Control for Enterprise Web Service

Electronic commerce and electronic shopping have become popular services on the Internet. As a consequence, some Web servers suffer periodic overloads, which degrades server performances and can even cause service down outages.

We have developed the active Web gateway (AWG), a Web proxy server, to control traffic accessing the Web. Using AWG as the front-end of a Web servers stabilizes the server's performances. AWG has (1) a traffic-shaping function that suppresses excessive access to the server, (2) a priority-controlling function that transfers high-priority requests in preference to normal requests at the HTTP layer, (3) an access-regulation function that regulates the maximum number of accesses to each URL in order to prevent service outages due to excessive access to a specific URL, and (4) a load-balancing function that evenly distributes the access requests among several Web servers.

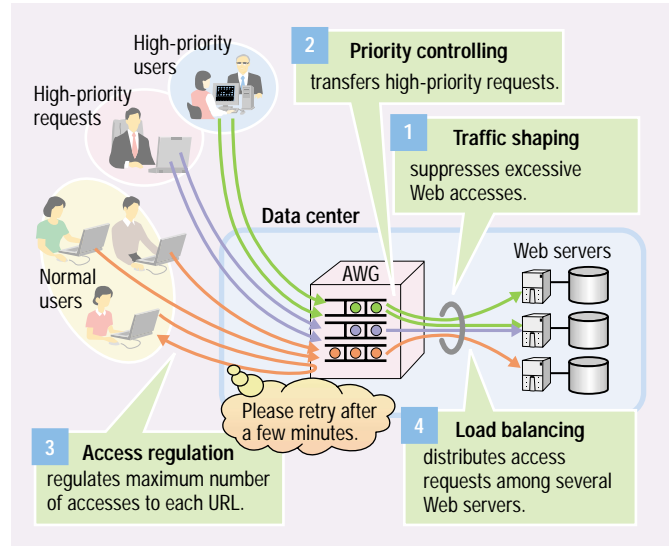

Web traffic control by AWG

## Probe Card for LSI Chips Featuring Narrow-pitch Pads

LSI chips manufactured for mobile and other devices are becoming increasingly smaller, incorporating a greater number of external connection pads as the degree of circuit integration advances. Consequently, the pad pitch has become extremely narrow. As a result, establishing a reliable contact with the pads by using contactors designed for electrical inspection has become much more difficult. We have developed a probe card, incorporating micro-contacts and wiring formed on a polyimide film using micro-machining and thin-film technologies, that can reliably test LSI chips featuring narrow-pitch electrodes.

Principal Features of the Probe Card

- (1) The Probe Card can be used to test LSI chips having hundreds of pads that are formed with pitches as narrow as  $35\ \mu\text{m}$ .
- (2) The contactors have sharp edges with small shape/dimension variability, enabling reliable contact with the pads at low pressure, which minimizes damage to the pads.
- (3) The contactors, which are constructed from hard, wear-resistant metals, are highly durable and require little maintenance.

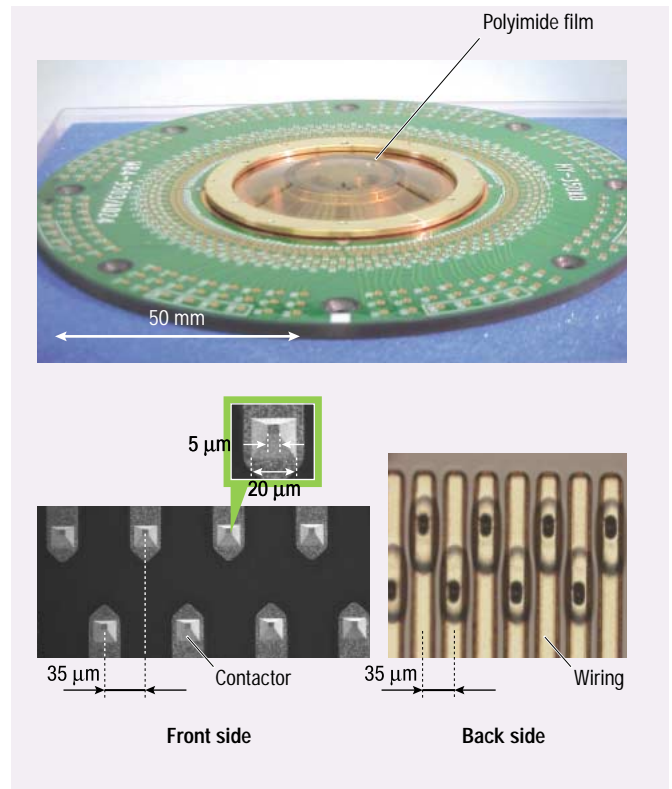

Appearance of the probe card (top), a contactor (lower left), and the wiring (lower right)