

# Traceability System for Manufacturer Accountability

Shinichi Kojima  
 Hiroshi Nakanishi  
 Kazuo Yoda  
 Hiroshi Sora

*OVERVIEW: In recent years, regulations concerning the observance of environmental laws have been made stricter, particularly in the EU (European Union), but in the rest of the world community as well. To protect their brand images, it has become essential for companies to respond to requirements for improvement of product quality and accountability to the customer. That has created a demand for a "traceability system" for managing the information related to individual products over the entire product lifecycle, beginning with the planning stage and including design, manufacture, maintenance and disposal. On the other hand, the management of information on individual products involves an immense amount of data, which severely affects the performance of data search and retrieval. To deal with this problem, Hitachi developed a real-harmonious BOM (bill of materials) product traceability system, which employs an on-memory computing engine produced by the Turbo Data Laboratories, Inc. to improve computation performance and achieve efficient data search. We have also developed an accountability system that is built on a real-harmonious BOM as the kernel and is capable of verifying the individual history of each product item.*

## INTRODUCTION

IN February 2003, the EU (European Union) approved a draft of the RoHS (restriction of hazardous substances), a regulation which limits the use of certain harmful substances and will be put into effect in July 2006. The effect of that regulation will be that, in principle, the regulated substances cannot be used in products sold in the European market. If it is determined that a particular harmful substance is contained in a product, it is highly likely that a recall order will be issued for that product, which would result in loss of customer trust and possible exclusion from the market. To avert such a worst-case situation, companies have need for thorough product management that enables a fast response should a problem arise.

Motivated by this situation, Hitachi has instituted the Eco & PLM (ecology and product lifecycle management) project at several plants. We have developed a real-harmonious BOM (bill of materials) product traceability system for data acquisition, storage and management over the product lifecycle and an accountability system in which real-harmonious BOM serves as the core. The real-harmonious BOM product traceability system is described here (see Fig. 1).

## PRODUCT TRACEABILITY

### System Requirements

In this system, when a problem arises concerning a shipped product, that product is first inspected to determine the cause of the problem. Then, a search is made for other shipped products that contained the problem part and the destinations to which they were shipped are determined. Measures are also taken to prevent the occurrence of the same problem in products that are to be shipped. Generally, if there is a problem with the material of a part, the cause of the problem is often present in other products in the same manufacturing lot.

That series of operations requires the search and retrieval of data concerning the product (BOM), production method BOP (bill of process) and basis (design). A summation of chemical substances is also done.

The system requirements for implementing product traceability under such assumptions are defined below:

- (1) When a problem with a shipped product has arisen, determine the range of the possibility of the same problem occurring again.
- (2) In that situation, prevent the re-occurrence of the same problem.
- (3) For any shipped product, search for and retrieve

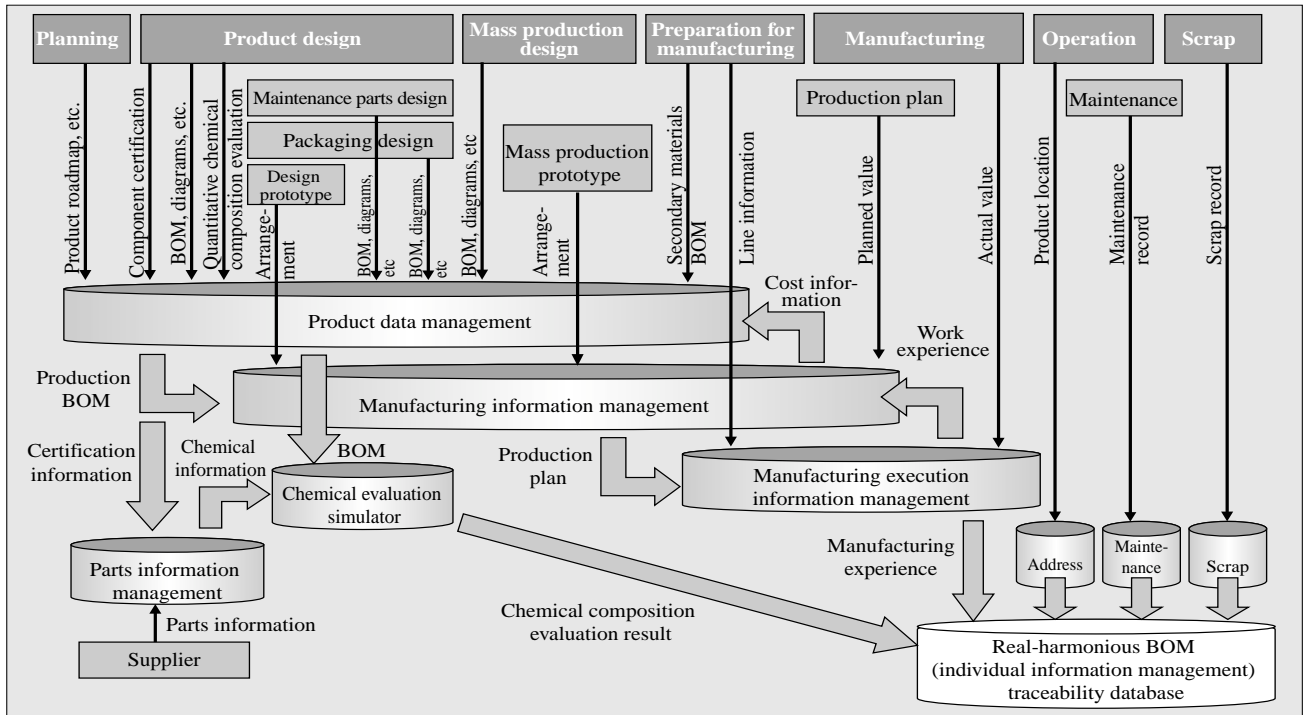

**Fig. 1—Configuration of Product Traceability System.**  
 The information generated in each phase of the product lifecycle is collected, recorded in an individual information database with relational information, and stored. This makes it possible to follow the information links to determine the range of effect, etc. when a problem arises.

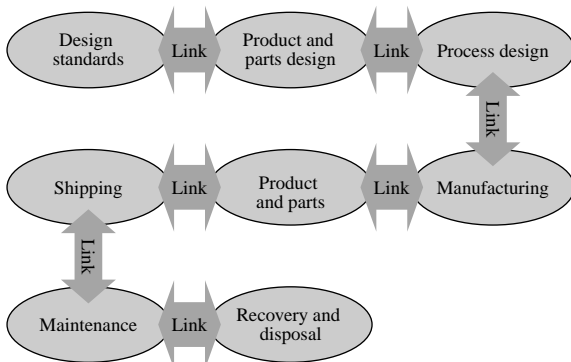

**Fig. 2—Linking Information.**  
 The information generated in each phase of the product lifecycle is linked to the information from the other phases. Accurate recording of the relations among the information allows the implementation of product traceability.

data on the product (BOM), production method (BOP) and basis (design).

**Linking Information**

When considering the making of a product, first the product and parts are designed according to the design standards of the company. Then, the process for manufacturing the product is designed, and the actual production is done. The manufactured product then undergoes distribution in the market,

maintenance, recovery, disposal, recycling and other such processes. The product traceability system creates an accurate chain of the information generated for individual product items in each of those processes. Doing so makes it possible to extract whatever information is required (see Fig. 2).

**Issues in System Development**

The product traceability system manages information on individual products. If, for example, 50,000 units of a certain model of product have been shipped, then the data for 50,000 units is stored. Such a huge amount of data makes it difficult to maintain good performance in the search function. Overcoming such a problem is an important issue in the development of this system.

**SPECIAL FEATURES OF REAL-HARMONIOUS BOM**

**Real-harmonious BOM System Configuration**

Real-harmonious BOM comprises an acquisition subsystem, a storage subsystem, a computation subsystem, and a Web application (see Fig. 3).

The acquisition subsystem recognizes the links among the manufacturing information, maintenance information and other information collected from

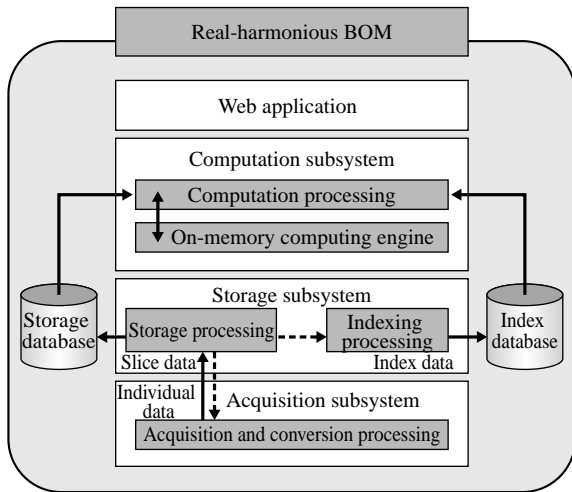

Fig. 3—Real-harmonious BOM System Configuration. Real-harmonious BOM comprises an acquisition subsystem, a storage subsystem, a computation subsystem and a web application.

various systems. It restructures the information and converts it to the individual information required for product traceability.

The storage subsystem segments the information input from the acquisition subsystem into optimum units and stores it in a database. It also indexes the enormous amount of individual information that is added each day for efficient search.

The computation subsystem, in response to a user request, uses the index to search the huge amount of

data for the target information. After obtaining the information, this subsystem performs various kinds of computation and totaling at high speed and returns the results to the user.

The web application passes a processing request that corresponds to a user search request to the computation subsystem and sends the results of the computation and summing processing to the user.

To achieve high-speed processing for a huge amount of data, a real-harmonious BOM employs an on-memory computing engine, a technology for ultra-high-speed processing produced as middleware by Turbo Data Laboratories, Inc.

### Acquisition Subsystem

The acquisition subsystem accepts data from outside the system, assigns relations among the items of information and stores them internally in a real-harmonious BOM. A special feature of this subsystem is that when selecting the parts that constitute a product or semi-processed article, it is possible to automatically select the part lot of procured goods. This function looks up the period of use of procured products and selects the part lot; if a part from multiple lots were used within the same period, the information is passed to the storage subsystem as multiple candidates for lots that may have been used, rather than narrowing the multiple lots down to a single lot.

Furthermore, when the acquisition subsystem

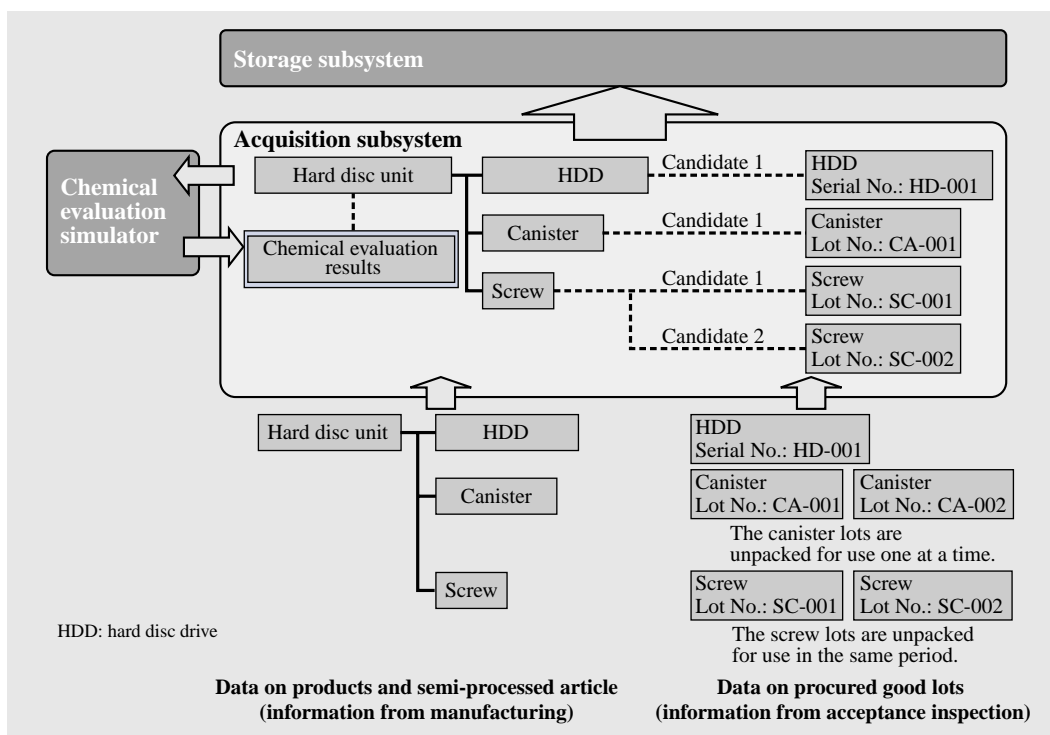

Fig. 4—Overview of Acquisition Subsystem. This subsystem accepts data from an external system and assigns relations among the data.

collects product and semi-processed article configuration information, a chemical evaluation simulator is used to sum up and evaluate the amount of substances contained in the product. By doing this processing in the acquisition subsystem, a record can be kept of the chemical content of all shipped products (see Fig. 4).

## Storage Subsystem

### (1) Storage processing

The product traceability system must store the individual information for all of the products that are manufactured and shipped every day. However, the amount of such individual data is great, so storing all the data input from the acquisition subsystem in a single file would result in a huge file size. This opens the possibility that the server memory may be insufficient when the data is loaded into memory for the computation processing, thus preventing the data from being loaded into memory.

To allow efficient use of the huge amount of individual data that is acquired and stored each day, a real-harmonious BOM can segment the data input from the acquisition subsystem into multiple files (data

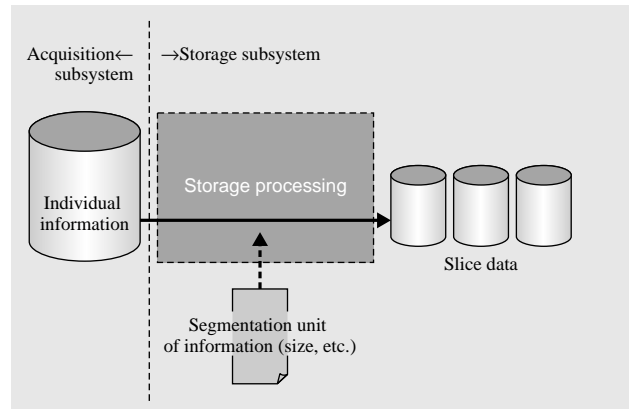

Fig. 5—Overview of Storage Subsystem.

The individual data input from the acquisition subsystem is segmented into multiple files (slice data) based on size or some other criteria.

slices) based on the amount of data or some other units (see Fig. 5).

### (2) Index generation processing

When searching for information, it cannot be known which slice of the slice data that has been segmented and stored in the database by the storage processing contains the target information. If the location of the target information cannot be known, it

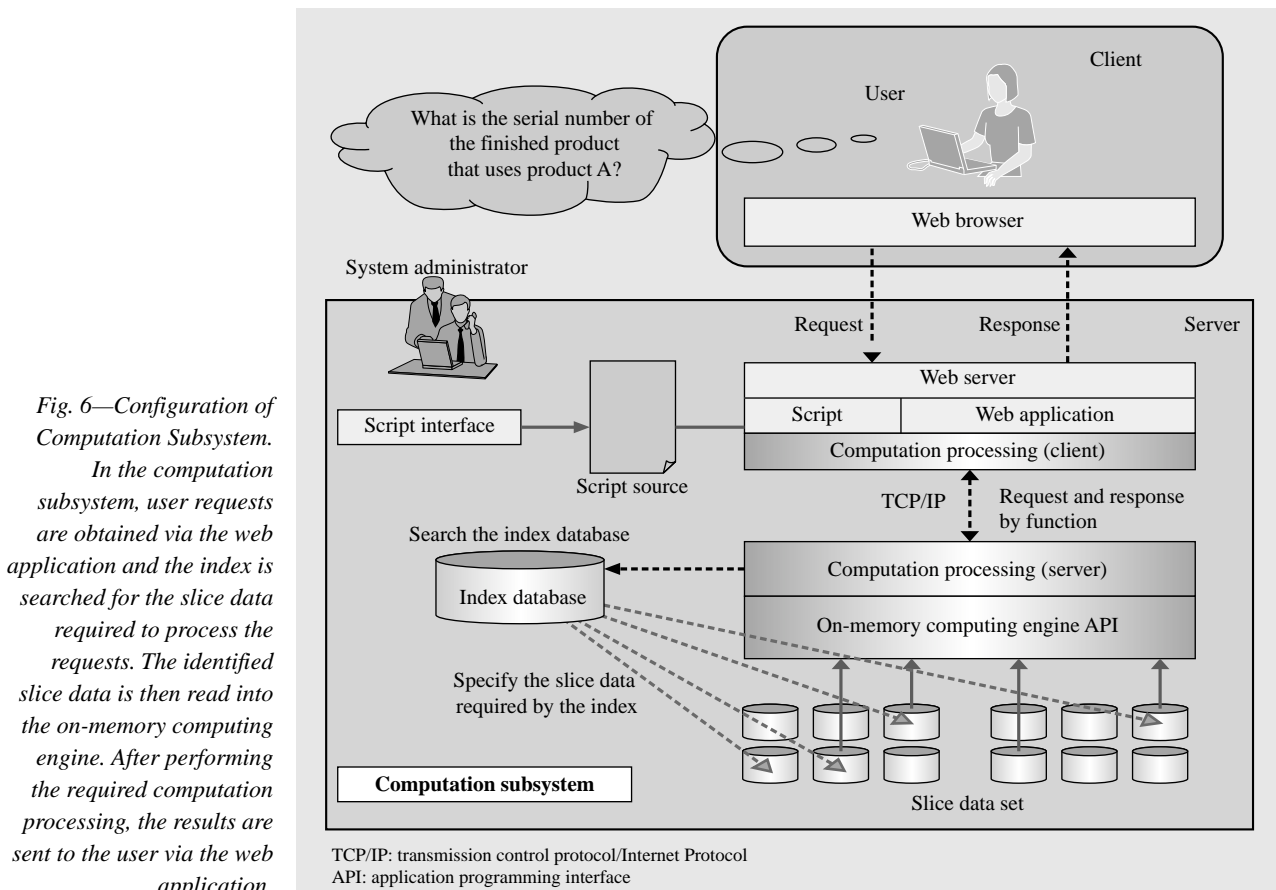

Fig. 6—Configuration of Computation Subsystem.

In the computation subsystem, user requests are obtained via the web application and the index is searched for the slice data required to process the requests. The identified slice data is then read into the on-memory computing engine. After performing the required computation processing, the results are sent to the user via the web application.

is necessary to access the huge files of from several hundred gigabytes to several terabytes of data that are needed to implement product traceability in order to find the target data. This would result in an impractically long search time.

For efficient management of the huge amount of individual information that is acquired and stored daily, a real-harmonious BOM generates an index that allows fast search for the location of the target information in the huge amount of stored data. This index can be used to minimize the number of times slice data is accessed, thus improving system performance.

## Computation Subsystem

### Computation processing

The computation subsystem controls the sequence of processing that begins when a user request is obtained via the web application. The sequence continues with searching of the index database for the slice data that is required for processing the request and the reading of the identified slice data into the on-memory computing engine. It ends with the passing of the results to the web application when the necessary computation and summation processing has been completed. In the computation processing, the system administrator or other such person can use the script interface to write script source for external requests to be processed in the same way as user requests obtained via the web browser (see Fig. 6).

### Processing by on-memory computing engine

The on-memory computing engine achieves high-speed computation by using an algorithm developed independently by the Turbo Data Laboratories, Inc. This engine performs the data processing entirely in main memory to avoid the reduction in performance associated with accessing the hard disk. It also implements ways of processing a large amount of data at one time, such as data structures that reduce the amount of main memory used and running in a 64-bit addressing space:

Considering the long-term storage of data, a real-harmonious BOM requires data structures designed to satisfy the conditions listed below.

- (1) Smaller data files
- (2) Storage of past data that is almost never accessed on an external medium so that it can be deleted from the disc volumes managed by a real-harmonious BOM
- (3) The addition of tables and items with future expansion of the use of a real-harmonious BOM shall not affect legacy data.

Combining this engine with the indexing described above makes it possible to segment the data into units that can be possessed in main memory. Furthermore, file sizes become smaller within a relational database because the segmented data units can be compressed. The addition of tables or items will not affect legacy data because it can be done in units of data segments.

The computation subsystem calls these on-memory

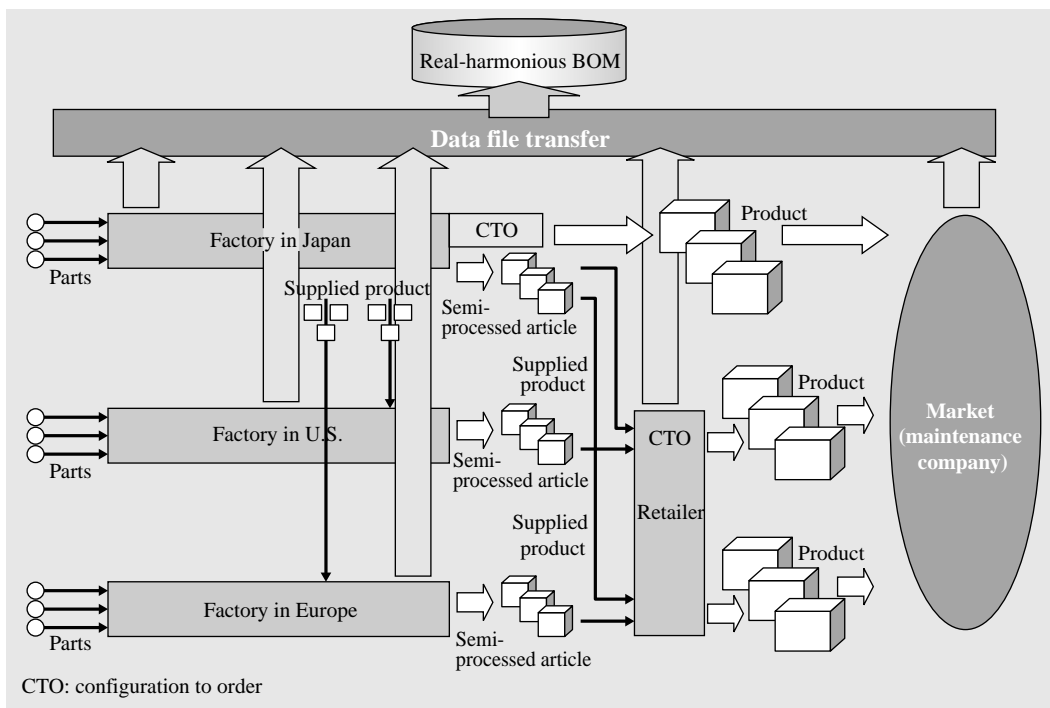

Fig. 7—Construction of Traceability System at Hitachi Experimental Facility. Both domestic and overseas factories are involved, and information is received from overseas sales companies as well.

computing engine sliced data files into main memory and performs the computation.

## FUTURE DEVELOPMENT

Currently, this product traceability system is being constructed at a Hitachi experimental facility as part of the Eco & PLM project. This facility handles CTO (configuration to order) production by overseas sales companies as well as domestic and overseas plants. Real-harmonious BOM collects various kinds of information from these manufacturing sites and performs various kinds of data processing on servers managed by local offices. The lines connecting real-harmonious BOM and overseas plants are slow now, so the system is designed to reduce the amount of data exchanged to the minimum (see Fig. 7).

After the construction of the system at the experimental facility has been completed, application of the system will be extended to other facilities one by one. Currently, the work process and data flow used at the experimental facility is being analyzed and divided into the parts that can be used at other facilities as well and the parts that are specific to each facility. From the common parts, templates are designed. Furthermore, attention will be given to the facility-specific parts as well, aiming for a general design that can cope with various types of facilities for smooth transition when the system is expanded.

In addition to expanding system application to other departments, we also plan to establish solutions for marketing to Hitachi customers. The entire PLM system will be marketed, rather than the real-harmonious BOM alone. We will continue to propose solutions based on Hitachi's approach and experience in the design of the entire PLM system, including the

roles assigned to the individual systems. In the proposal of solutions, the templates created in application of the system within Hitachi can be utilized.

We are assembling these templates into a real-harmonious BOM application set which we call the "Best-practice Framework." As the opening shot, we plan to introduce a chemical evaluation template that involves the summing up of the chemicals contained in a product, the evaluation of the chemicals, and checking for compliance with various regulations.

In future development, we plan to enhance real-harmonious BOM to include management of the information required for quality analysis, financial information such as sales price and original value, information on the purchasing user, and information on movements in the product market in addition to information concerning environmental regulations centered around individual product information. We believe that, in the future, the analysis of such data will allow fast and accurate decision-making and business judgments, leading to a change from the current "defensive system" to an "aggressive system."

## CONCLUSIONS

We have described the real-harmonious BOM, a product traceability system an IT solution developed to support manufacturer accountability. This system, as the name suggests, centers on individual product information. It collects various kinds of information that is managed by other systems, assigns relationships among the items of information, and can represent the activities of manufacturing companies themselves. Hitachi will continue developing the "Best-practice Framework" and making proposals on the basis of the implementation examples described here.

## ABOUT THE AUTHORS



**Shinichi Kojima**

*Joined Hitachi, Ltd. in 1987, and now works at the Eco & PLM Business Promotion Center, the Industrial Systems Division, the Information & Telecommunication Systems. He is currently engaged in the development of PLM traceability systems.*

*Mr. Kojima can be reached by e-mail at [shkojima@itg.hitachi.co.jp](mailto:shkojima@itg.hitachi.co.jp).*



**Kazuo Yoda**

*Joined Hitachi, Ltd. in 1985, and now works at the Eco & PLM Business Promotion Center, the Industrial Systems Division, the Information & Telecommunication Systems. He is currently engaged in the development of PLM traceability systems.*

*Mr. Yoda can be reached by e-mail at [kyoda@itg.hitachi.co.jp](mailto:kyoda@itg.hitachi.co.jp).*



**Hiroshi Nakanishi**

*Joined Hitachi, Ltd. in 1985, and now works at the Eco & PLM Business Promotion Center, the Industrial Systems Division, the Information & Telecommunication Systems. He is currently engaged in the development of PLM traceability systems.*

*Mr. Nakanishi can be reached by e-mail at [hnakani@itg.hitachi.co.jp](mailto:hnakani@itg.hitachi.co.jp).*



**Hiroshi Sora**

*Joined Hitachi, Ltd. in 2002, and now works at the Eco & PLM Business Promotion Center, the Industrial Systems Division, the Information & Telecommunication Systems. He is currently engaged in the development of PLM traceability systems.*

*Mr. Sora can be reached by e-mail at [h-sora@itg.hitachi.co.jp](mailto:h-sora@itg.hitachi.co.jp).*