

User Manual

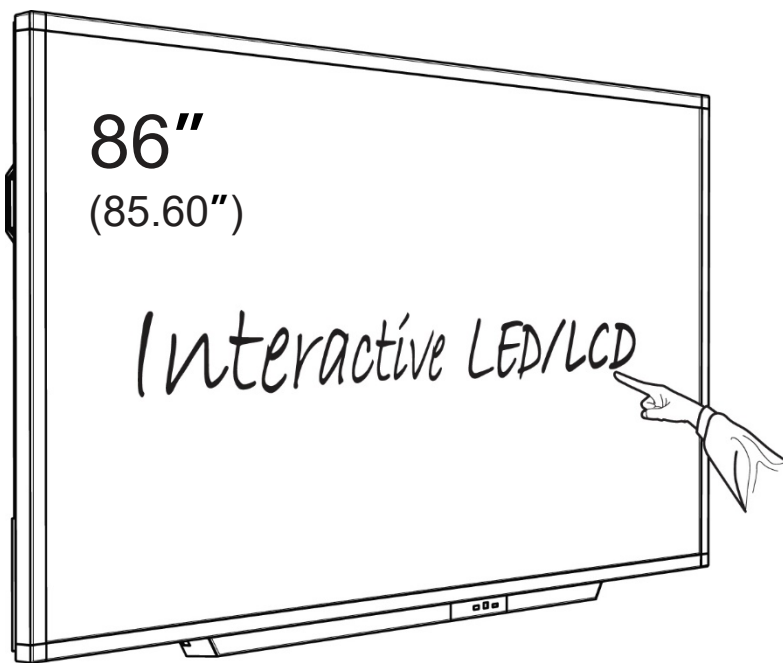

Model: HILS86204
Interactive Flat Panel Display

Contents

1. Important safety Instructions.....	3
1.1 Safety precaution.....	5
1.2 Maintenance.....	9
2. Introduction.....	10
3. Product Description.....	11
3.1 Front View.....	11
3.2 Rear View.....	12
3.3 Connection	15
4. Remote Controller.....	17
5. Home Menu Description.....	19
5.1 Menu Overview.....	19
5.2 OPS.....	22
5.3 External Source.....	23
5.4 File Manager.....	24
5.5 Mirroring.....	25
5.6 Drawing.....	30
6. Setup Menu Description.....	42
7. Product Specification.....	49
8. Product Dimensions.....	51
9. Troubleshooting.....	52
9.1 Product Self-Diagnosis.....	52
9.2 Before Requesting Service.....	52

1. Important Safety instructions

[SAFETY WARNING]

- To reduce the risk of fire or electric shock, do not expose this product to rain or moisture.
- To prevent injury, this product must be securely attached to the floor/wall in accordance with the installation instructions.
- To reduce the risk of electric shock, do not remove the back cover
- Refer to qualified service personnel if needed.

◆ Icons used in this manual

	CAUTION RISK OF ELECTRIC SHOCK. DO NOT OPEN.			The lightning flash and arrowhead within the triangle indicates that there is dangerous voltage inside the product.
				The explanation point within the triangle indicates that there are important instructions accompanying the product.

[WARNING] means,

If you ignore the warning message, you may be seriously injured or there is a possibility of accident or death.

[CAUTION] means,

If you ignore the caution message, you may be slightly injured or the product may be damaged.

[NOTE] means,

The note helps you understand and use the product safely. Please read the note carefully before using the product

- ◆ This device complies with part 15 of the FCC Rules. Operation is subject to the following two conditions: (1) This device may not cause harmful interference, and (2) this device must accept any interference received, including interference that may cause undesired operation.

CAUTION: Changes or modifications not expressly approved by the party responsible for compliance with the FCC Rules could void the user's authority to operate this equipment.

- ◆ When moving the product, please grab the handles behind and the bottom of the product as shown below picture.
- The product must keep horizontal and upright position when moving.
- Do not hold the corner of the product when you grab the bottom of the product.

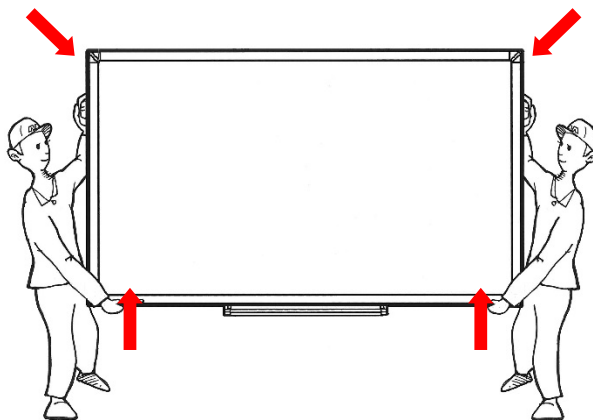

[Recycling Policy]

(For USA)

Dispose of this product in accordance with applicable environmental laws. For product recycling and disposal information, contact your local government agency or www.eRecycle.org (in California), the TIA at www.ecyclingcentral.com (in the US) or the Electronic Product Stewardship Canada at www.epsc.ca (in Canada). For more information, call 800.HITACHI.

1.1 SAFETY PRECAUTION

Note) The color and design may differ by each model and the product specification are subject to change without notice for performance enhancement.

1.1.1 Power

[Warning]

- Do not use damaged power cord, plug nor loose socket. It may cause electric shock or fire.
- Do not connect multiple devices into a single s socket. It may cause fire due to overheating.
- Do not touch with wet hands when remove or plug the power cord to avoid electric shock.
- Insert the power plug into socket firmly. It may cause fire when the connections are unstable.
- Connect the power cord to a grounded wall socket. There is risk of electric shock or injury.
- Do not bend nor pull the power cord and place heavy objects over the power cord. It may occur cord damage and this may result in fire.
- Please clean only with dry cloth when the plug pin or socket are dusty. It may cause fire.

[Caution]

- Do not unplug the power plug while the product is operating. It may damage the product due to electric shock.
- Only a power cord specified by product manufacturer are recommended.
Do not use the power cord from other devices. It may cause electric shock or fire.
- Hold the plug itself when unplugging the power plug from the wall socket. If not, there is risk of electric shock or fire.
- Before moving or installing this product, be sure to turn off the power and disconnect the power cord. To turn this product off completely, you must pull the power plug out of the wall socket. Consequently, the power plug must be easily and readily accessible at all times.

1.1.2 Installation

[Warning]

- Do not install near any heat sources such as radiators, or other devices that produce heat. It may cause electric shock or fire.
- When mounting a product on the wall, make sure not to install the product by hanging the power and signal cables on the back of it.
- Consult with your local dealer or specialized engineer to mount the product on the wall, and use the screws and wall mounts that meet the VESA standard. Any damages or injuries by misuse or using an improper accessory are not covered by the warranty.

- Leave a 10 cm (4 inches) (minimum) space from the wall for proper ventilation. If not, it may cause fire.
- Keep the packing anti-moisture material or vinyl packing out of the reach of children. Anti-moisture material is harmful if swallowed. If swallowed by mistake, force the patient to vomit and visit the nearest hospital. Additionally, vinyl packing can cause suffocation. Keep it out of the reach of children.
- Please note that the product must be supported on proper stands or installed according to the manufacturer's recommendations. The product that are inappropriately situated on unstable shelves, inclined planes, or vibrating places, etc., may fall over, resulting in injury.
- To reduce the risk of fire or electrical shock, do not expose this product to rain, moisture or other liquids or dust. It may cause electric shock or fire.
- Keep the product away from direct sunlight.
- Keep the product out of the reach of children and install on the stable and flat place. NEVER allow children to climb on or play on the product or the furniture and stands on which the product is placed.

[Caution]

- Do not allow an impact shock or any objects to fall into the product, and do not drop anything onto the screen.
- Make sure the product is turned off, unplugged, and all cables have been removed. It may take more than 4 people to than carry.
- Do not press or put stress on the front panel of the product.
- If the product is installed in a place where the operating conditions considerably, a serious quality problem may occur due to the surrounding environment. In this case, install the product only after consulting our dealer about the matter. (Places exposed to microscopic dust, chemicals, too high or low temperature, high humidity, airports or stations where the product is continuously used.)

1.1.3 Cleaning

[Warning]

- Before cleaning the product, unplug the power cord and wipe gently with a soft cloth to prevent scratching.
- Do not spray water or other liquids directly on the product as electric shock may occur.

[Caution]

- Do not push, rub, or hit the surface with your fingernail or a sharp object, as this may result in scratches on the screen and image distortions.

- Do not use any chemicals, such as waxes, benzene, alcohol, thinners, insecticides, air fresheners, or lubricants, as these may damage the screen's finish and cause discoloration.
- Do not spray liquid onto the surface. If water enters the product, it may result in fire, electric shock, or malfunction.

1.1.4 General Usage

[Warning]

- To reduce the risk of electric shock, do not open the cover or back. No user serviceable parts inside. Refer to qualified service personnel.
- Before moving or lifting the product, disconnect the power cord and all cables.
- The route cords and cables connected to the product so that they cannot be tripped over, pulled or grabbed.
- Do not stick metal objects or any other conductive material into the power cord. Do not touch the end of the power cord while it is plugged in. It may result in fire, electric shock.
- Unplug this product during lightning storms or when unused for long periods of time.
- Do not block any ventilation openings. Install in accordance with the manufacturer's instructions.
- To reduce the risk of fire or electrical shock, do not expose this product to rain, moisture or other liquids. Do not touch the product with wet hands. Do not install this product near flammable objects such as gasoline or candles, or expose to direct air conditioning.
- NEVER allow children to climb on or play on the product or the furniture on which it is placed. It may cause severe injury to children.
- Use only with a cart, stand, tripod, bracket, or table specified by the manufacturer, or sold with the product. When a cart is used, be careful when moving the cart/product combination to avoid injury from tip-over.
- Install where it cannot be pushed, pulled over or knocked down.
- It is recommended to move the product in the box or packing material that originally came in.
- When holding the product, the screen should face away from you to avoid damage.

[Caution]

- If a fixed image displays on the screen for a long period of time, it will be imprinted and become a permanent disfigurement on the screen. This is image burn or burn-in and not covered by the warranty.
- Avoid displaying a fixed image on the screen for a long period of time (2 or more hours for LCD) to prevent image burn. Recommend to power off or set the screen saver mode when not in use.
- When watching the screen, take 5 to 15 minute breaks every hour. Viewing screen for a long period of time may cause fatigue or eye strain.

- Take care not to touch the ventilation openings. When watching the screen for a long period, the ventilation openings may become hot. This does not affect the performance of the product or cause defects in the product.
 - Do not install this product on a wall if it could be exposed to oil or oil mist. This may damage the product and cause it to fall.
 - To install batteries in remote control, open the battery cover, replace batteries matching (+) and (-) ends to the label inside the compartment, and close the battery cover. Failure to match the correct polarities of the battery may cause the battery to burst or leak, resulting in fire, personal injury, or ambient pollution.
 - To prevent to swallow the small accessories for children, keep the accessories out of the reach of children.
-
- ❖ The product must keep horizontal and upright position when moving. Hold the top and bottom of the frame firmly. Handles are only for the supporting purpose.
 - ❖ When attaching the stand to the set, place the screen facing down on a cushioned table or flat surface to protect the screen from scratches by more than 2 people,
 - ❖ Make sure that the screws are fastened tightly. (If they are not fastened securely enough, it may tilt forward after being installed.)

1.2 MAINTENANCE

1.2.1 Cleaning

[Warning]

- When cleaning, unplug the power cord and wipe gently with a soft dry cloth to prevent scratching.
- Do not spray water or other liquids directly on the screen as electric shock may occur.
- Do not clean with chemicals such as alcohol, thinners, or benzene.

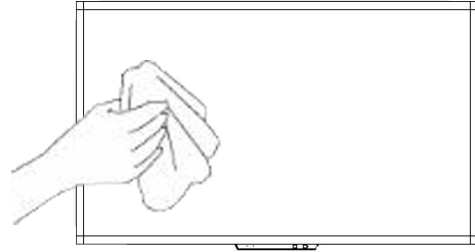

1.2.2 Installation

- Leave a 10 cm (4 inches) (minimum) space from the wall for proper ventilation. If not, it may cause fire or malfunction due to the high temperature product inside.

[When attaching the stand]

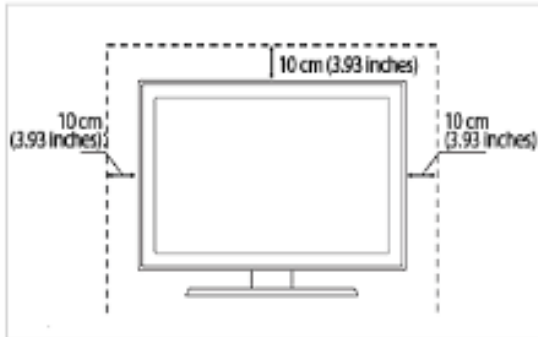

[When mounting on a wall]

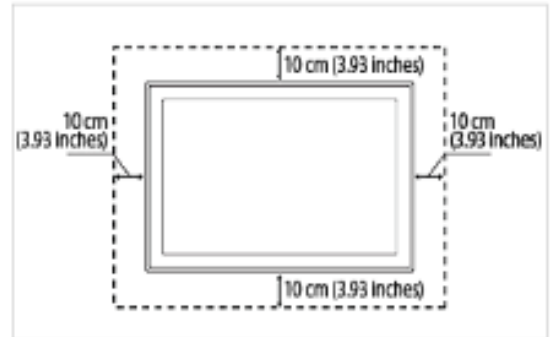

1.2.3 Panel

- Avoid displaying a fixed image on the screen for a long period of time (2 or more hours for LCD) to prevent image burn. Recommend to power off or set the power saving mode or screen saver when not in use.
- Due to technological constraints of the Panel manufacturer, the images generated by this product may appear either brighter or darker than normal by appr. 1ppm (parts per million) pixel.

The number of sub-pixels of a panel by size: The number of Sub-Pixels = Max. Horizontal Resolution x Max. Vertical Resolution x 3.

For example, if the maximum resolution is 1920 x 1080, the number of sub-pixels is $1920 \times 1080 \times 3 = 6,220,800$.

[Condensation on the glass surface]

- It may occur the dew condensation on the glass surface inside when the product is turned on for the first time or after it has not been used for a long time.
- This is a temporary phenomenon caused by the temperature difference between external and internal of the product, which is not a malfunction.
- If the symptom occurs, it disappears after a certain time (about 1 ~ 3 hours) after turning on the product.









2. Introduction

- ◆ Check your product box for the following items. If there are any missing accessories, contact the local dealer where you purchased your product.

The illustrations in this manual may differ from the actual product and item.



LCD/LED Display

Accessory			
			
			
	User Manual	Warranty Card	
	HDMI Cable	USB Cable(for TOUCH)	Power Cable
	Remote Controller	Battery 1.5 V (AAA)	Pen X 2

3. Product Description

3.1 Front View

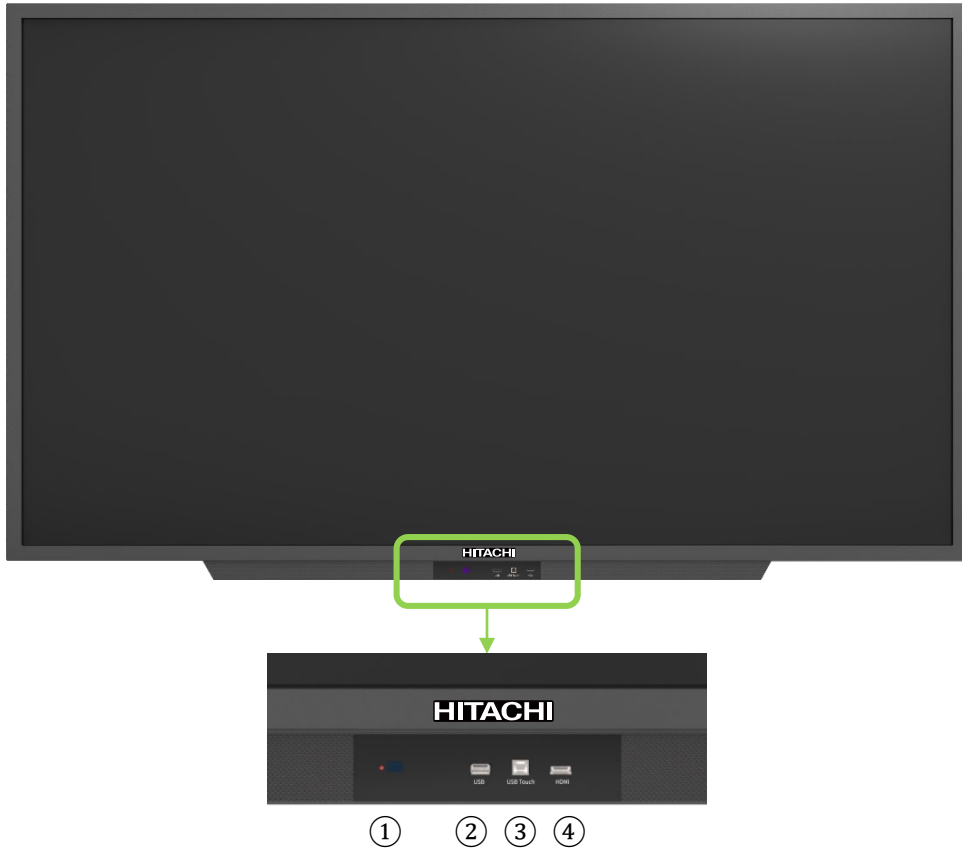

① LED Indicator

- Power ON mode: BLUE
- Power OFF(Standby) mode: RED
- Be sure to point the remote control at the remote control sensor on the LED/LCD Display.

② USB for OPS, Front or Rear

③ Touch USB: USB Port is available when Source External is selected.

④ HDMI Input (When connected, it changes to Source External.)

Important Notice

- ◆ The USB cable (3 m) that Hitachi provides in this accessory box is for use of connection to Touch USB at the back. Therefore, in case of connecting USB cable to Touch USB in front, separate USB cable is required and the length of cable is strongly recommended to be less than 3 m to make sure signal intensity of touch sensor work properly.

3.2 Rear View

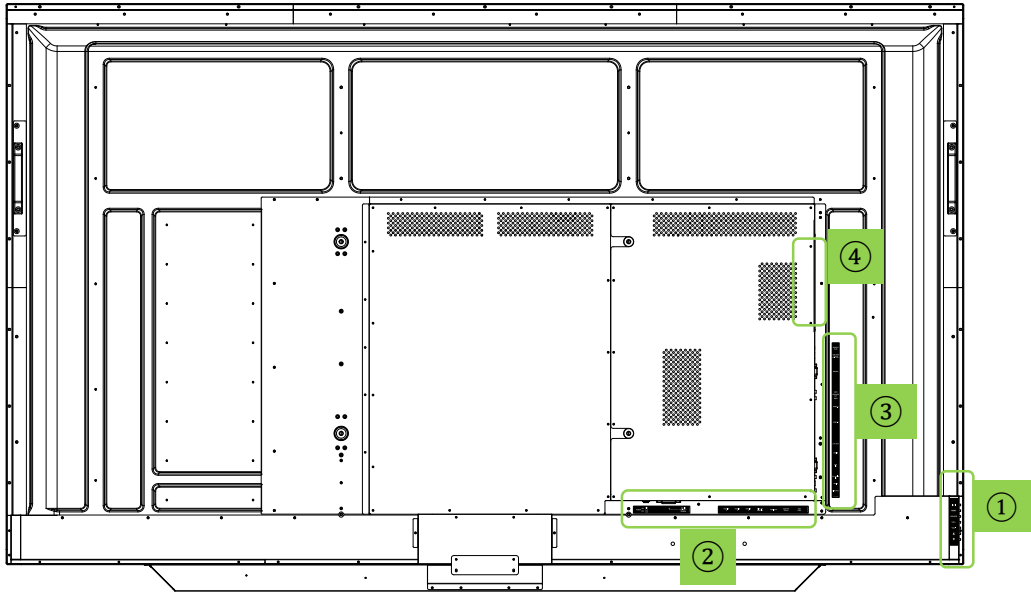

① Button Control

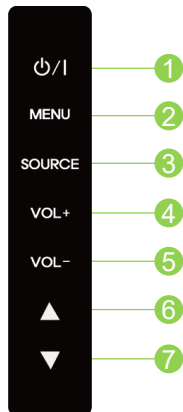

1	ON / OFF
2	Display the main screen menu
3	VGA, OPS, EXTERNAL, HDMI 1, HDMI 2, HDMI 3, DP
4	Volume Up (Right)
5	Volume Down (Left)
6	Move Up
7	Move Down

② Rear Panel Connections

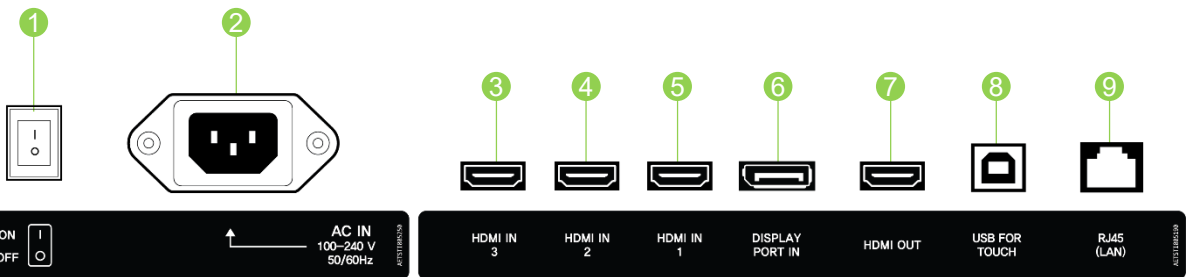

1	Power Switch : ON / OFF
2	AC IN : 100V~ 240V, 50/60Hz
3	HDMI 3 Input
4	HDMI 2 Input
5	HDMI 1 Input

6	Display Port
7	HDMI Output
8	USB For Touch
9	RJ45(LAN)

Note: HDMI 1 has separate USB for Touch located on ③

③ Rear Panel Connections

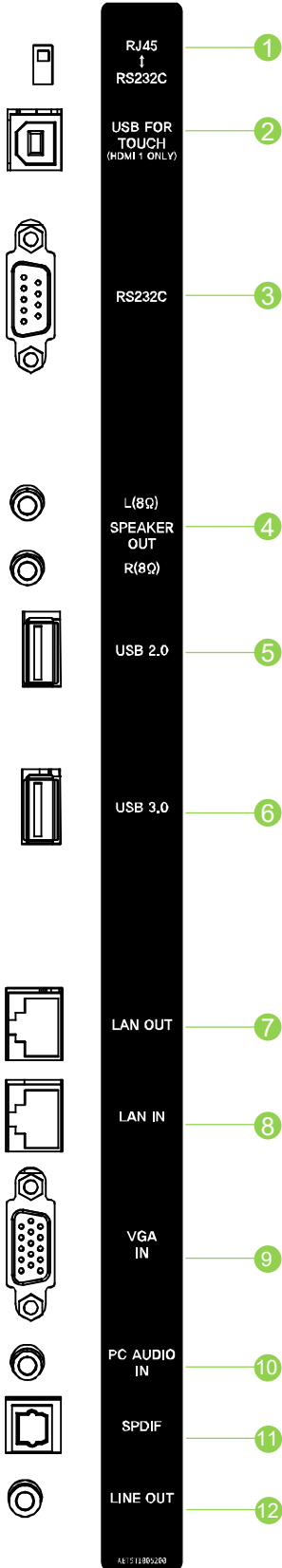

1	RJ45/RS232 SWITCH
2	USB FOR TOUCH HDMI1 ONLY
3	RS232C
4	SPEAKER OUT
5	USB 2.0 (Supports USB cam or camera function)
6	USB 3.0 (Supports USB cam or camera function)
7	LAN OUT
8	LAN IN
9	PC RGB IN
10	PC AUDIO IN
11	SPDIF
12	LINE OUT

④ Installing an OPS PC

There is a slot on ④ for OPS PC. When you need to install an OPS PC, remove screws and existing cover first and screw up again after mounting OPS PC in the slot.

⑤ AC cord holder



- To prevent the power cable from falling/shaking, you may use the cable holder if necessary. SCREW (4x11)

3.3 Connection

1) HDMI/Display Port Connection

To transmit digital video and audio signals from an external device to the screen, connect the HDMI/Display Port cables as shown in the following illustration.

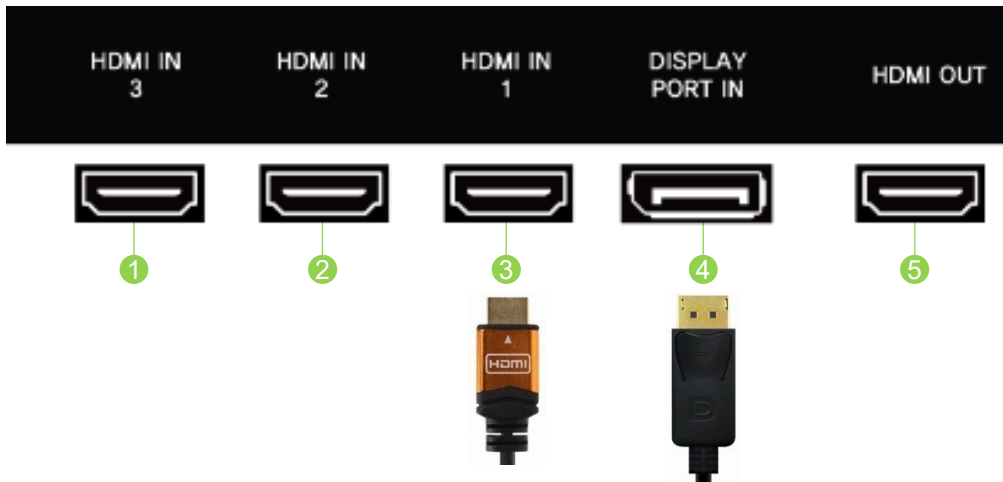

1	HDMI 3 Input – PC/ LAPTOP connect to the HDMI cable
2	HDMI 2 Input – PC/ LAPTOP connect to the HDMI cable
3	HDMI 1 Input – PC/ LAPTOP connect to the HDMI cable
4	DisplayPort Input – PC/ LAPTOP connect to the DisplayPort cable
5	HDMI Output – Connect the other monitor to transmit video data

2) VGA Connection

In case of transmission of digital video signal from an external device to the screen, connect the external device and the product with the VGA cable and to transmit an audio signal, connect an audio cable in PC AUDIO IN port separately.

3) Speaker Connection

To utilize an optional external audio system instead of the built-in speaker, connect a Ø3.5 stereo (L/R) cable in the port.

If it is connected to external speakers, internal speakers may not produce sound.

The connection is as below:

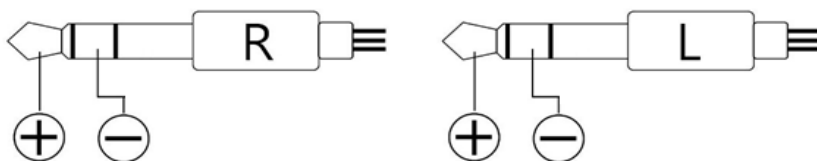

※ Note that when using an OPS PC Connection

- 1) Do not connect touch sensor USB cable to the port. (Touch sensor cable is already connected by internal OPS docking board.)

4) RS232C Connection

HITACHI Models supports two connection methods : RS232C and LAN standard.
Simultaneous connection of two standards is not supported.
Please select RS232C cable or LAN connection.

※ Note

How to select RS232C On/Off switch
RJ45(↑), RS232C(↓)

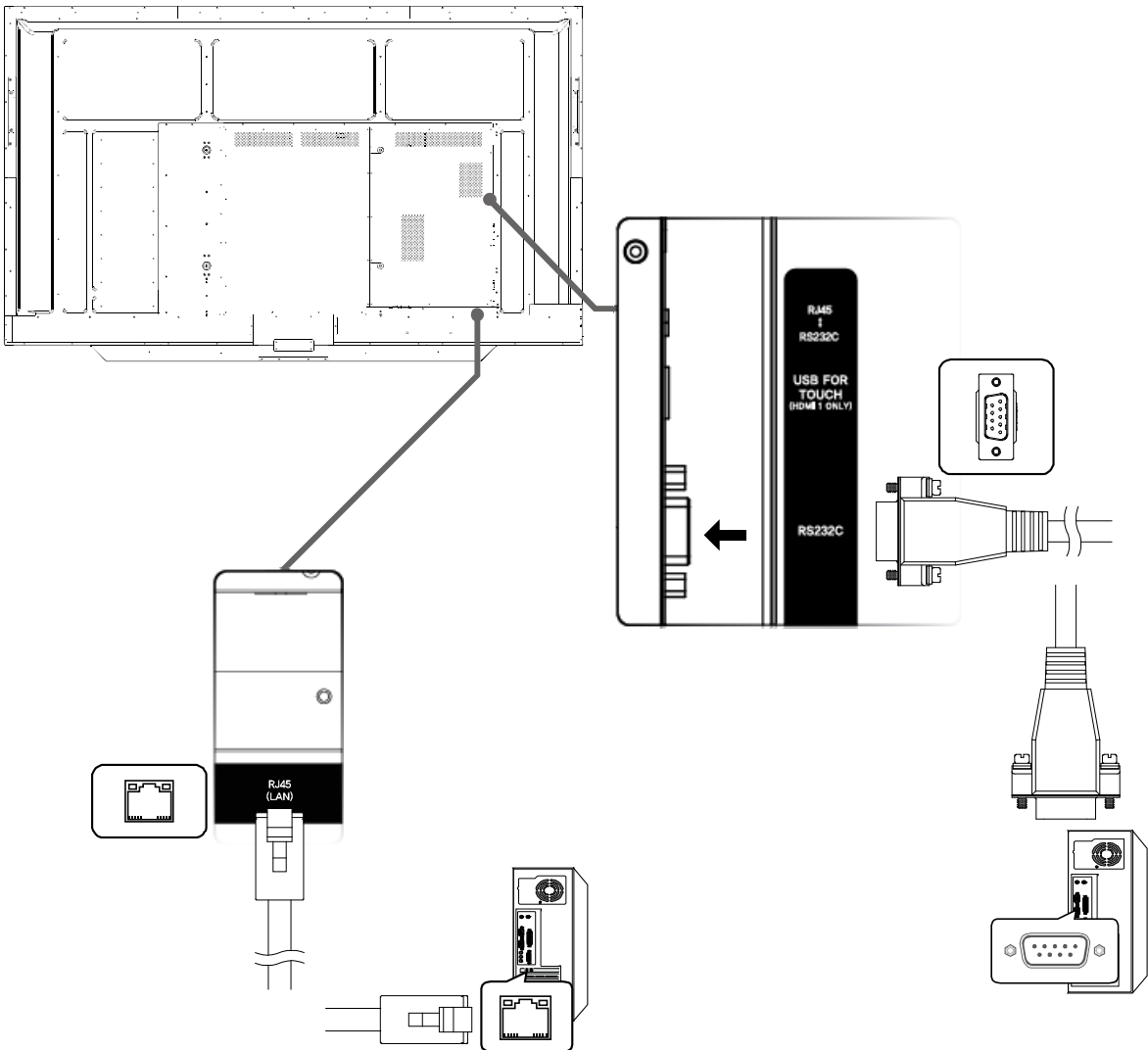

The RS232C port will not work once RJ45 is being used.

4. Remote Controller



Key Name	Description
⏻/I	Power ON/OFF.
SOURCE	Activates OSD menu of input source selecting. Navigates input source downwards.
▲	Navigates upper menu in main OSD menu. Navigates input source.
▼	Navigates down menu in main OSD menu. Navigates input source
▶	Navigates to next menu in main OSD menu.
◀	Navigates to previous menu in main OSD menu.
OK	Select the highlighted menu option.
MENU	Activates main OSD menu.
EXIT	Closes main OSD menu.
FREEZE	Allows you to capture and freeze an image from a moving image that you are watching.
VOL+	Volume UP
VOL-	Volume Down
MUTE	Toggles sound status of speaker.

4.1 How to insert battery

Insert the battery into proper polarities
Battery model: Battery 1.5V(AAA)

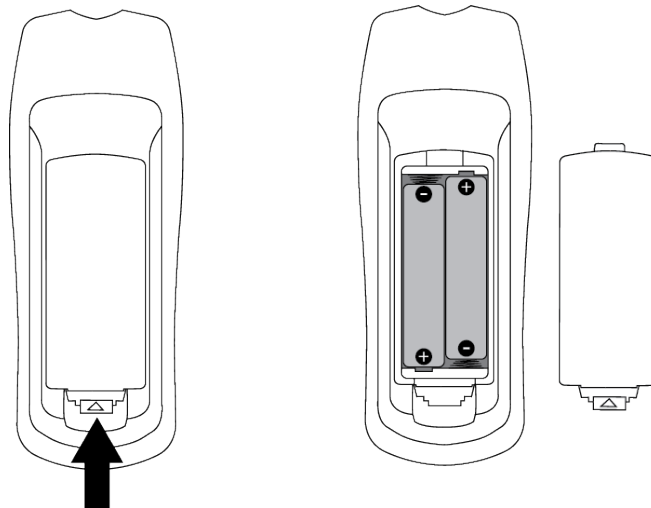

BATTERY PRECAUTIONS

These precautions should be followed when using batteries in this device:

- The batteries may last approximately one year depending on how much the remote control is used. Replace batteries when the remote operation becomes erratic.
- Use only the size and type of batteries specified.
- Be sure to follow the correct polarity when installing the batteries as indicated in the battery compartment. Reversed batteries may cause damage to the device.
- Do not mix different types of batteries together (e.g. Alkaline, Carbon-zinc or Rechargeable) or old batteries with fresh ones.
- If the device is not to be used for a long period of time, remove the batteries to prevent damage or injury from possible battery leakage.
- Do not try to recharge batteries not intended to be recharged; they can overheat and rupture. (Follow battery manufacturer's directions.)
- Please use caution when inserting batteries to avoid battery damage. If the spring terminal in the remote control remains in contact with a side of a damaged battery it can cause a short circuit. Never use damaged batteries as they can become very hot and are dangerous.
- Never expose batteries (battery pack or batteries installed) to excessive heat such as sunshine, fire or the like.

5. Home Menu Description

5.1 Menu Overview

In the home screen, you can see the following buttons:

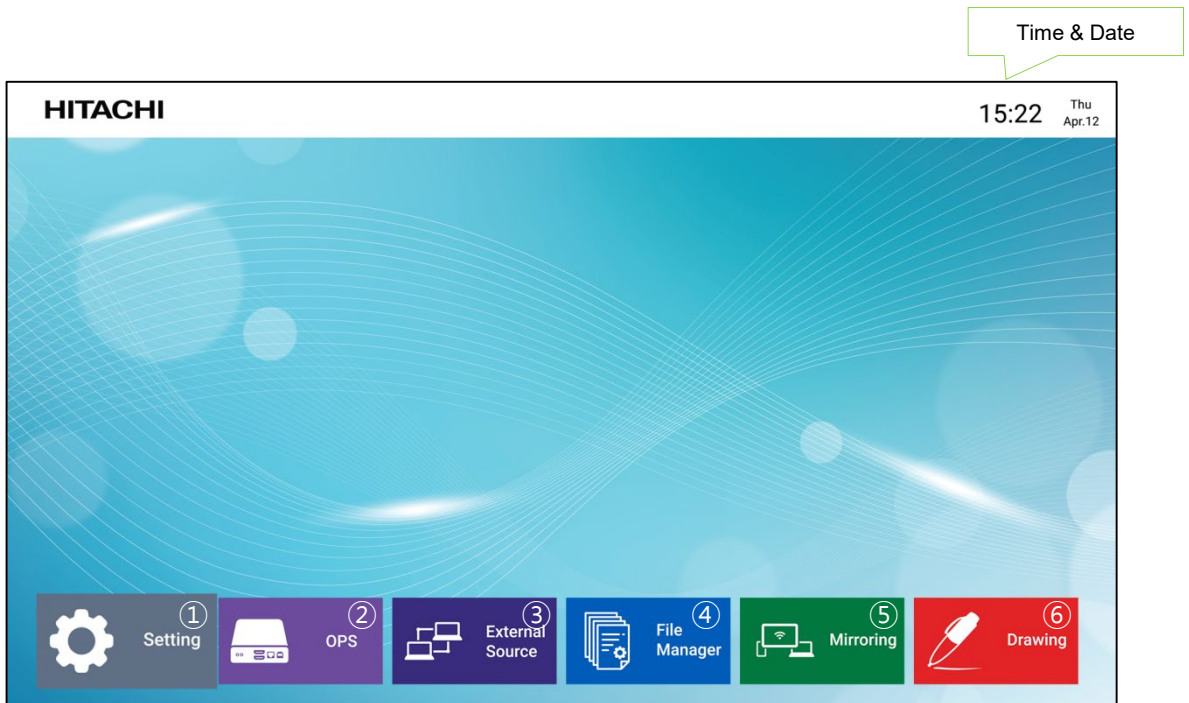

- ① **Setting**
Go to the setup
- ② **OPS**
Go to the OPS screen.
- ③ **External Source**
Go to the External Source screen which is connected through the HDMI Port in front.
- ④ **File Manager**
Run, move, copy or delete folders and files.
- ⑤ **Mirroring**
Select this button to connect with your smart device.
- ⑥ **Drawing**
Select the button to use the Drawing, writing application equipped on Interactive flat panel display.

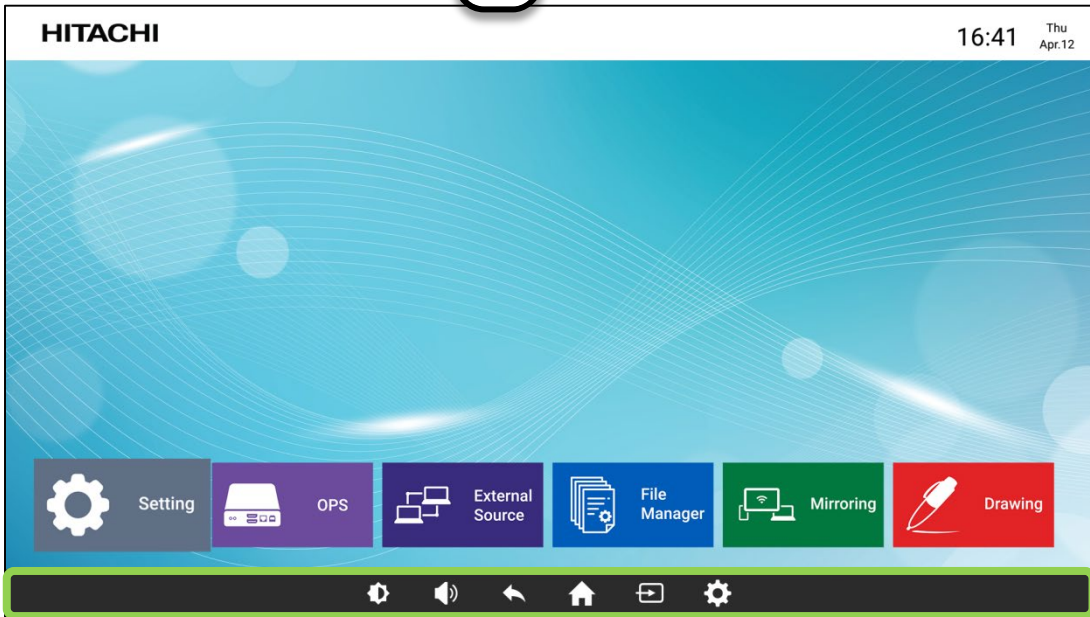
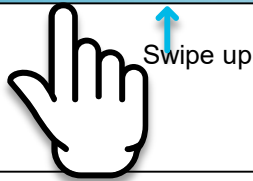
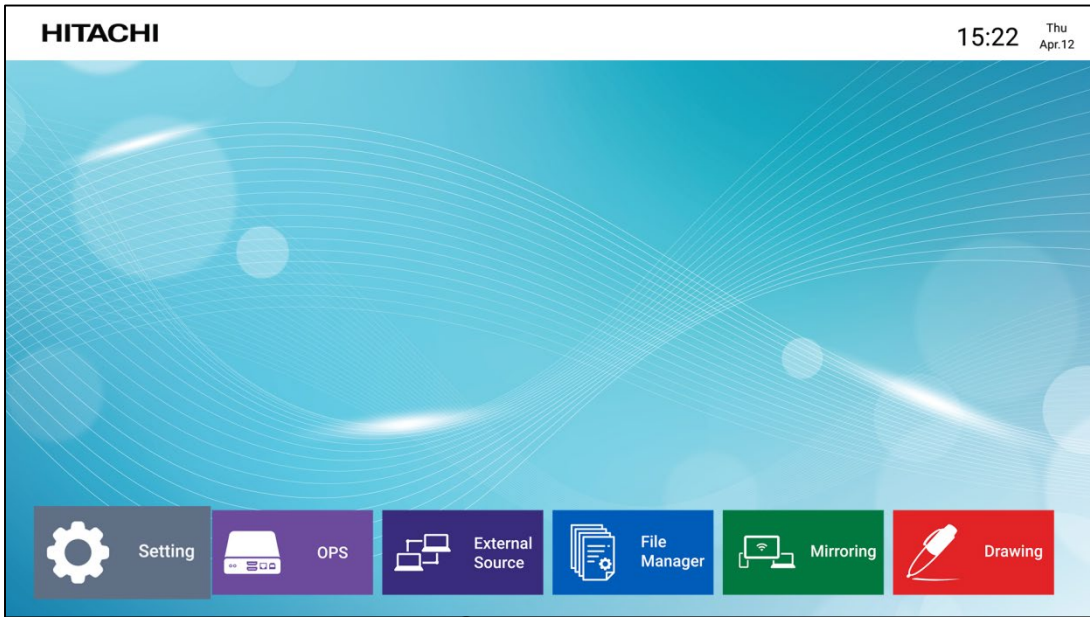

Home Menu

If you drag the bottom of the screen upwards, the hidden Home Menu pops up. With the Home Menu you can go to Brightness, Volume, Back, Home, Source, Setup.



Home Bar UI	Description
Brightness	Adjust the brightness.
Volume	Adjust the volume
Back	Move to the previous screen step.
Home	Go to the home screen.
Source	Call the external input window.
Setting	Go to the Setup

5.2 OPS(Open Pluggable Specification)

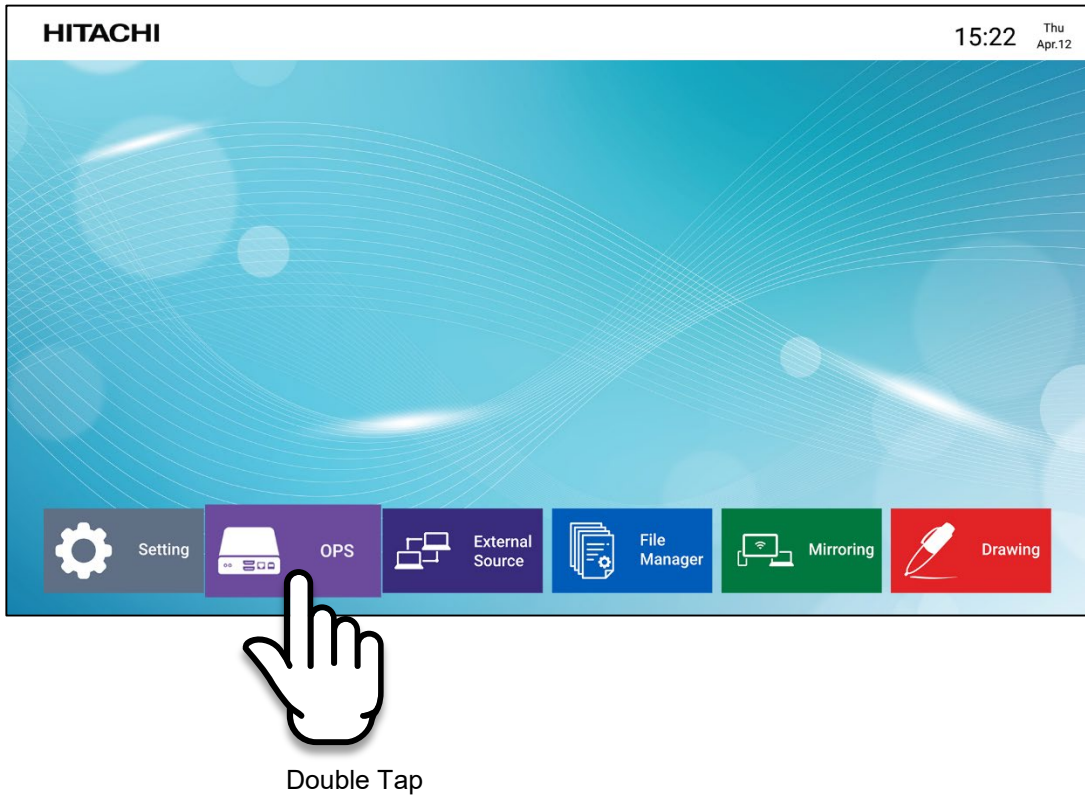

OPS(Open Pluggable Specification)

Computing module plug-in format available for adding computing capability to Flat Panel Display. Computing modules in the OPS format are available on Intel- and ARM-based CPUs, running operating systems including Microsoft Windows and Google Android.

5.3 External Source

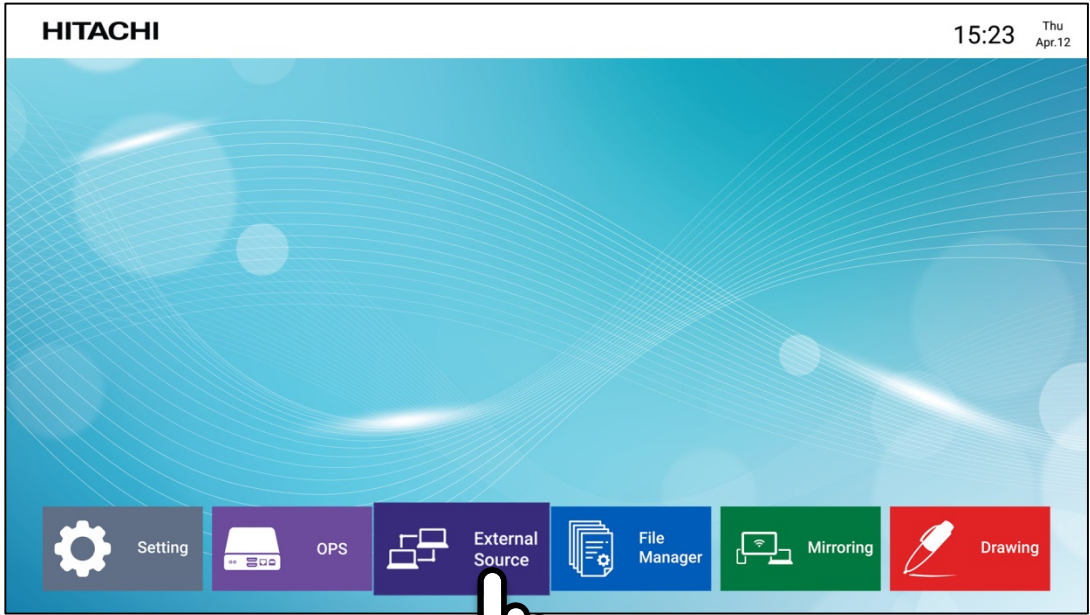

Double Tap

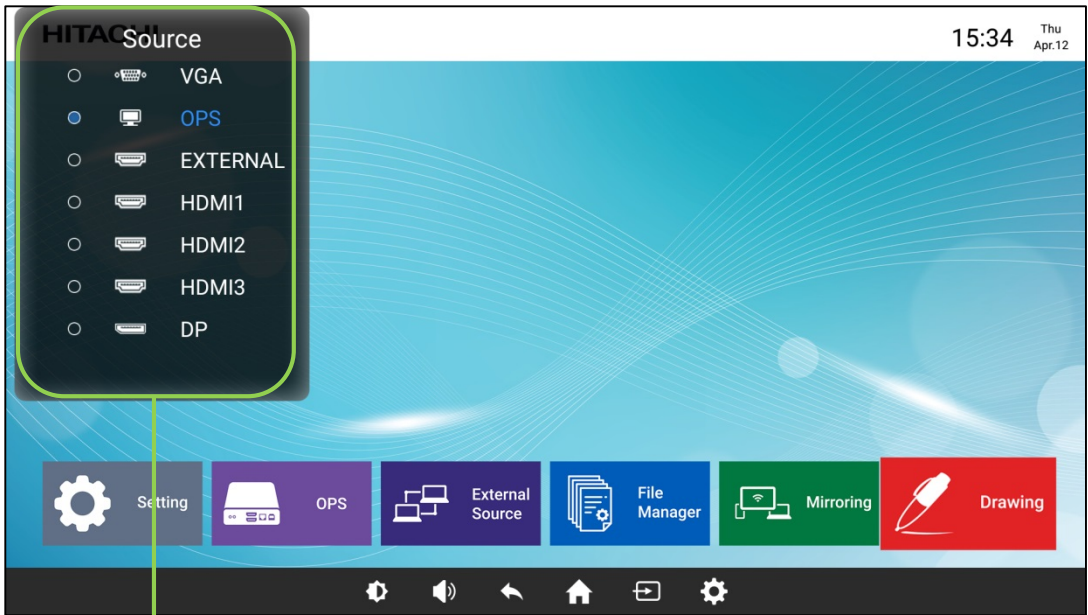

External Source
Double tap to choose a source.

5.4 File Manager

Create, open, copy, delete, and view folders and files



Double Tap

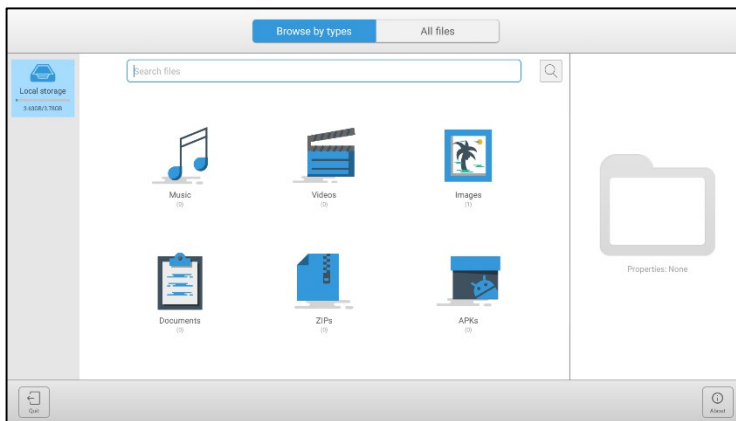

Browse by types

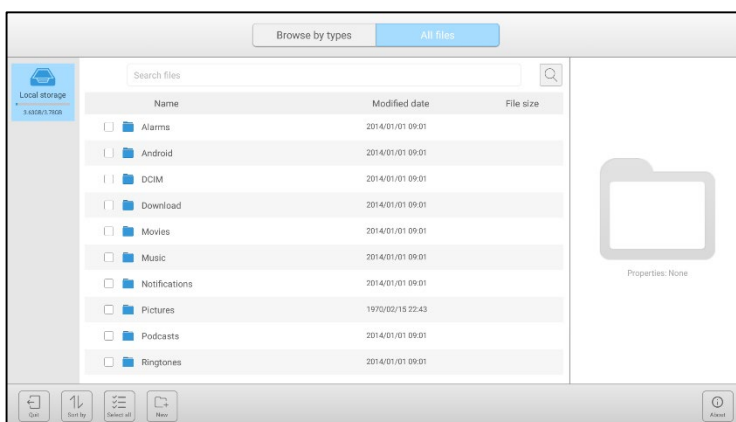

All files

5.5 Mirroring

Synchronize screens with smart devices

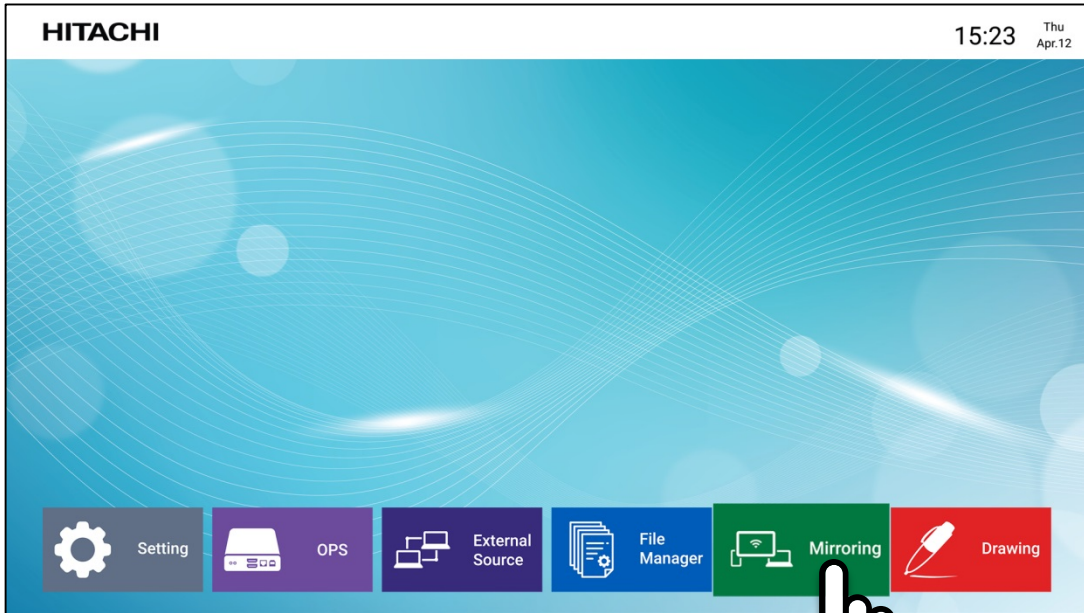

Double Tap

The image shows a business presentation slide. At the top, there is a photograph of a man in a blue shirt and tie smiling while holding a smartphone. Below the photo, the text "Enjoy Sharing Life" is displayed. Underneath that, a smaller line of text reads: "Make the user experience natural and enjoyable for home entertainment, business presentation, educational training and leisure games." At the bottom left, there is a QR code. To its right, there are three numbered instructions: "1. Connect your device to iptime5G", "2. Visit 'http://192.168.14.209:8000' with web browser or scan the QR-code to download app.", and "3. Launch EShare and click 'EShare-2138' to connect." At the bottom right, there is a gear icon followed by the word "Settings".

5.5.1. Eshare-Mobile users

- Precondition(To interwork, the devices should be in the same network)
- Download the OS executable file from the following site.
<http://d.eshare.tech>



1) Smart phone setting

- (1) Open PlayStore
- (2) Search EShare App
- (3) Download and install EShare App
- (4) Execute EShare App

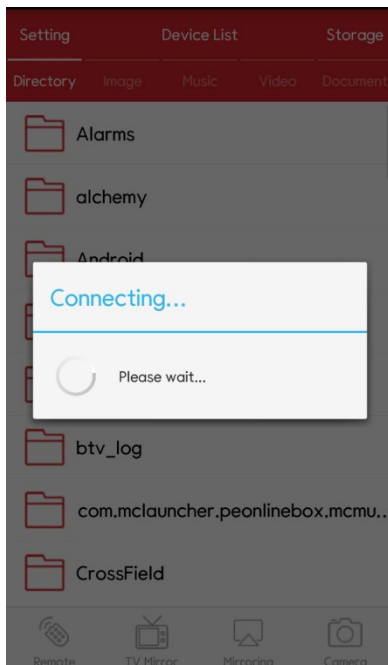

1) EShare(App)

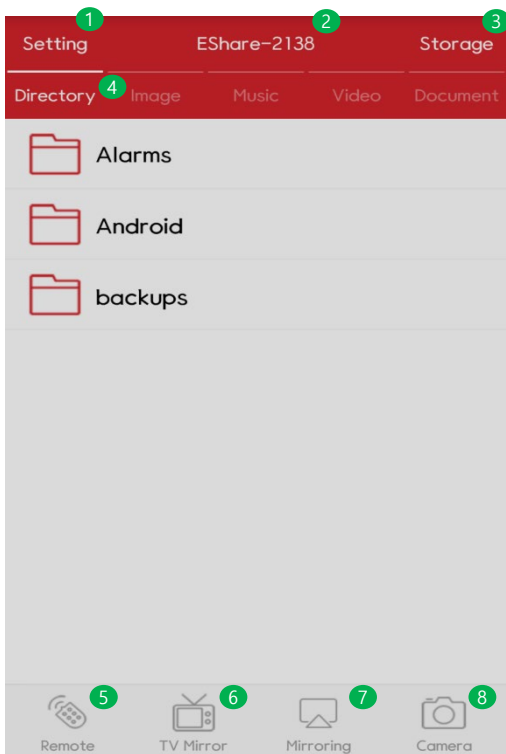

(1) Main Screen

- ① Setting
- ② Eshare Connect ID
- ③ Storage
- ④ Contents category
(Directory,Image,Music,Video,Document)
- ⑤ Remote mode
- ⑥ TV Mirror mode
- ⑦ Mirroring mode
- ⑧ Camera mode

2) Remote mode

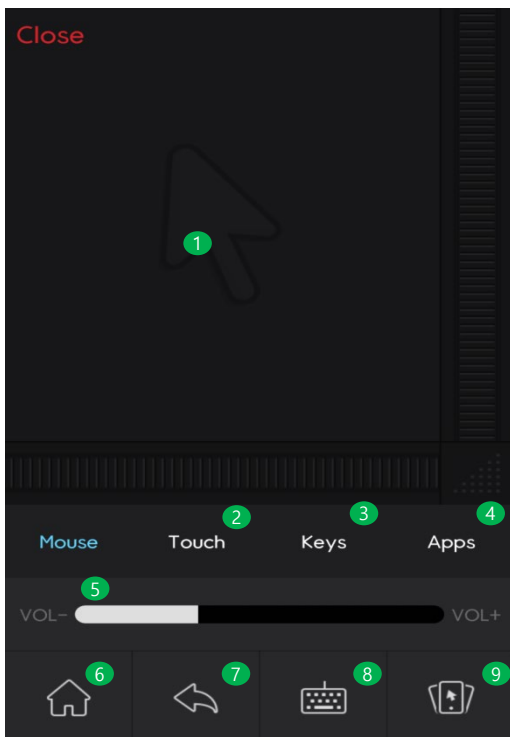

(1) Remote Screen

- ① Mouse pad
- ② Virtual touch mode
- ③ Virtual key mode
- ④ App mode
- ⑤ Volume Control
- ⑥ Move Main screen
- ⑦ Back
- ⑧ Keyboard activation
- ⑨ Motion mode

3) Virtual key mode

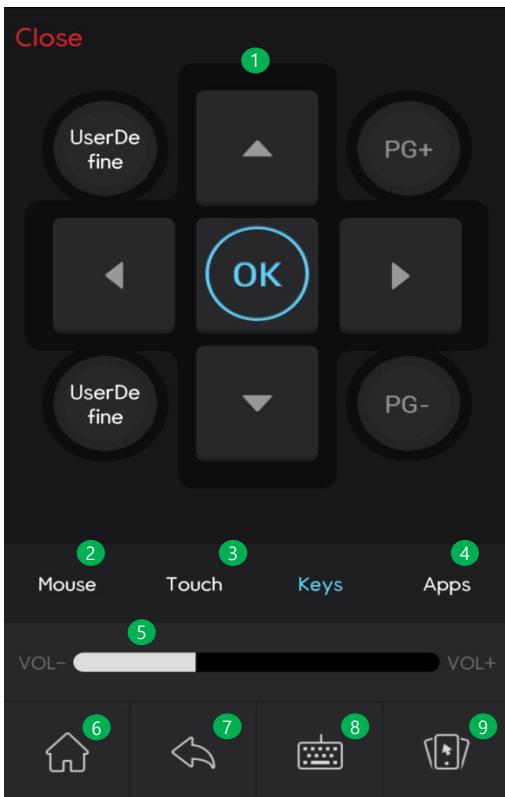

(1) Virtual key Screen

- ① Remote button
- ② Virtual mouse mode
- ③ Virtual touch mode
- ④ App mode
- ⑤ Volume Control
- ⑥ Move Main screen
- ⑦ back
- ⑧ Keyboard activation
- ⑨ Haptic mode

4) Camera mode

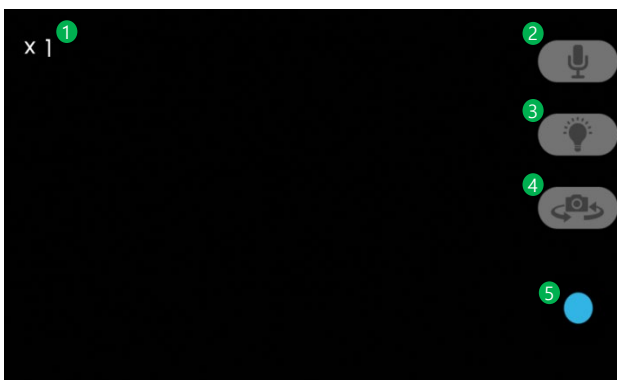

(1) Camera Screen

- ① Zoom state
- ② Mic Mute
- ③ Flash
- ④ Front/Back Camera selection
- ⑤ Shutter

5.5.2. Eshare-PC users

- Precondition(To interwork, the devices should be in the same network)
- Download the OS executable file from the following site.
<http://d.eshare.tech>



Enjoy Sharing Life
Make the user experience natural and enjoyable for home entertainment, business presentation, educational training and leisure games.

1. Connect your device to **iptime5G**
2. Visit "<http://192.168.14.209:8000>" with web browser or scan the QR-code to download app.
3. Launch EShare and click 'EShare-2138' to connect.

Settings

1) Notebook setting

- (1) Download and install EShare Client.exe
- (2) Execute EShare Client.exe
- (3) Share Notebook screen
- (4) Allows you to control your notebook screen with an interactive LED/LCD



5.6 Drawing

Allows the user to write on screen. Can be used for lectures and presentations.

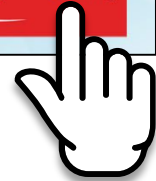
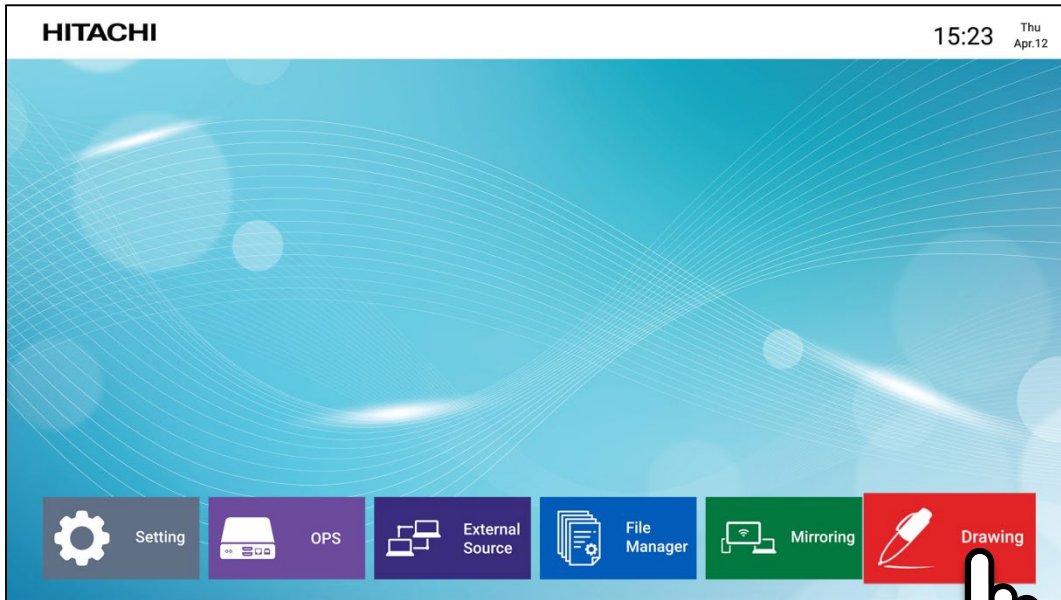

Double Tap

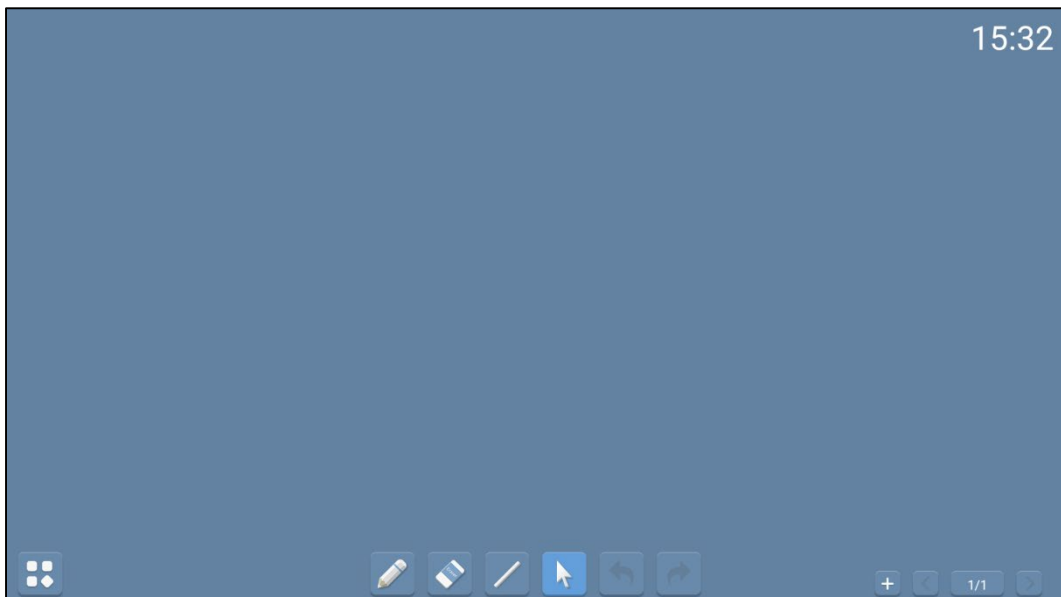

Gestures

1) 1 point : draw



2) 2 point : zoom in/out, adjust the size.

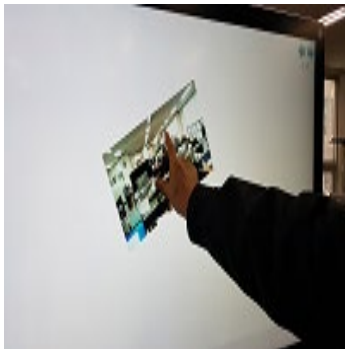
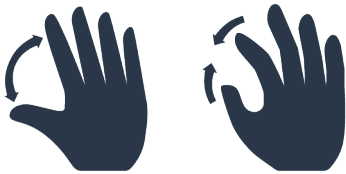

Icons on the main screen

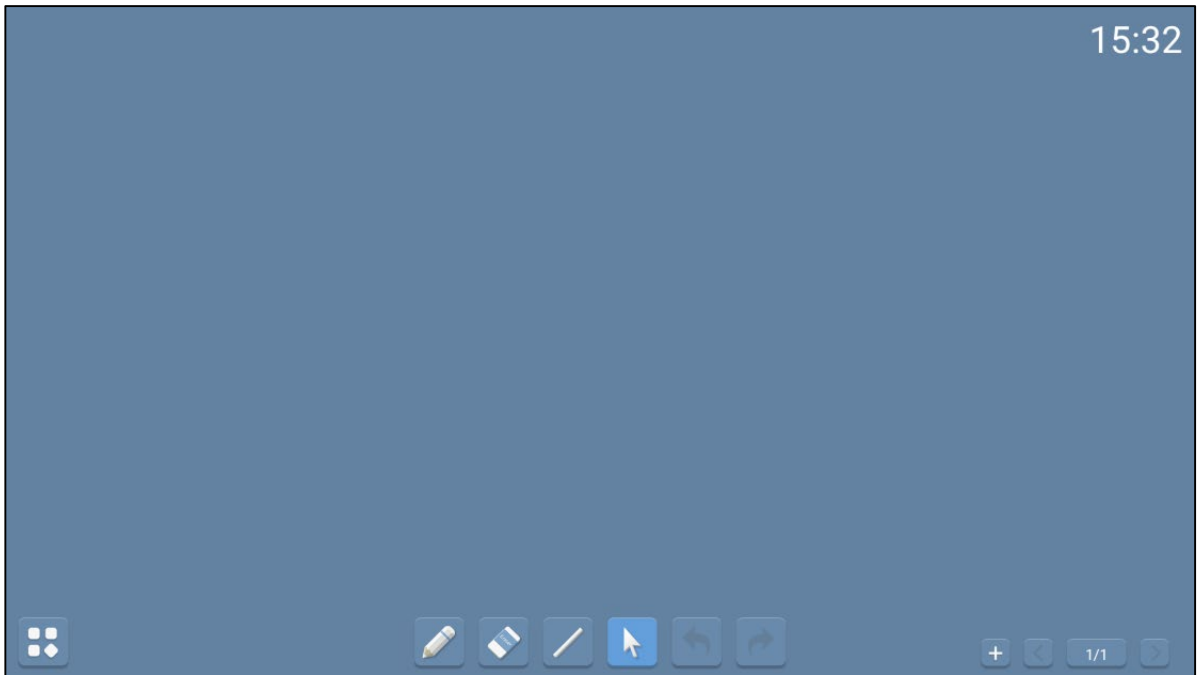

Icon	Name	Description
	Start menu	Menu with extra options
	Pen	Pen with customizable line weight, transparency, and color
	Eraser	Erase entire page or choose precision eraser
	Line	Line with customizable and figure
	Pointer	Selects a certain content.
	Undo	Undo the most recent action.
	Redo	Redo the most recent action.
	Add content	Add images saved on the device.
	Previous page	Move to the previous page.
	Next page	Move to the next page.
	Page	Current page / Total page

Start menu

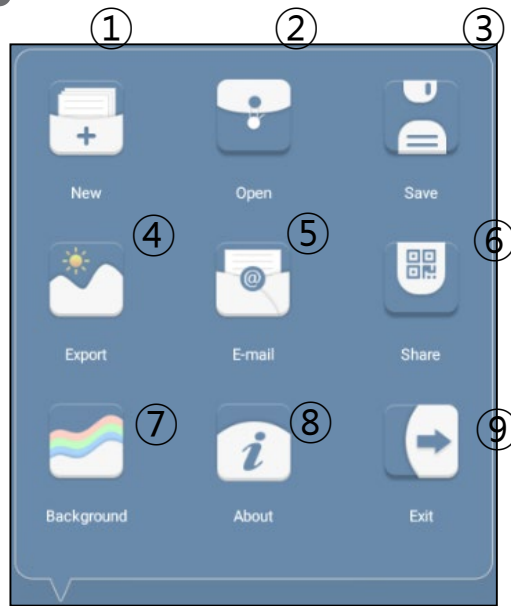

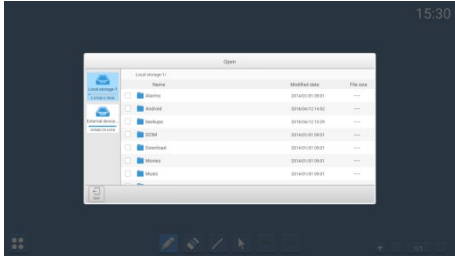
Option	Description
① New	New Task
② Open	Open *.zip file from a folder where it was previously saved. 
③ Save	Save the content on the page. (By default the content is saved in *.zip format. This file can be opened only in Drawing.)
④ Export	Export as Image file(*.png)
⑤ E-mail	Send to E-mail
⑥ Share	QR scan provide images.
⑦ Background	Choose the background
⑧ About	View information about the program
⑨ Exit	Close the program

Pen

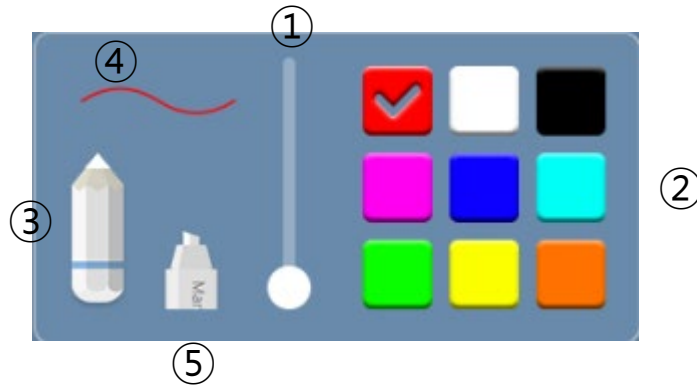

Option		Description
①	Line weight	Move the slider to increase or decrease the thickness of the line left by pen.
②	Color	Choose one the 9 available colors red, white, black, purple, dark blue, sky blue, green, yellow, orange.
③	Pen	The pen can be used immediately with preset line weight and color.
④	Preview	You can preview the changes as you're making them.
⑤	Marker Pen	The marker pen can be used immediately with preset line weight and color.

Eraser

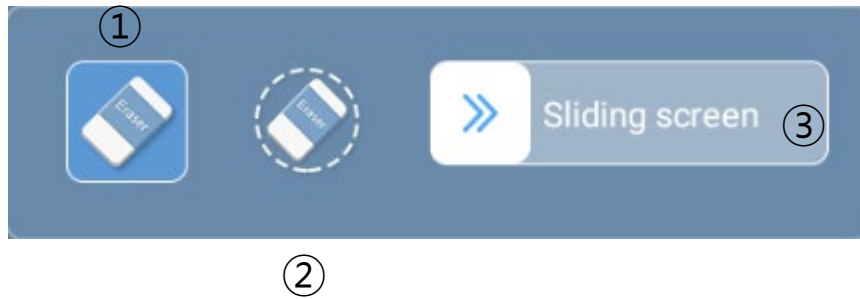

Option		Description
①	Eraser	Erases the content you touch.
②	Object Eraser	Select the object and remove
③	Sliding Screen	Remove all contents by sliding.

Line

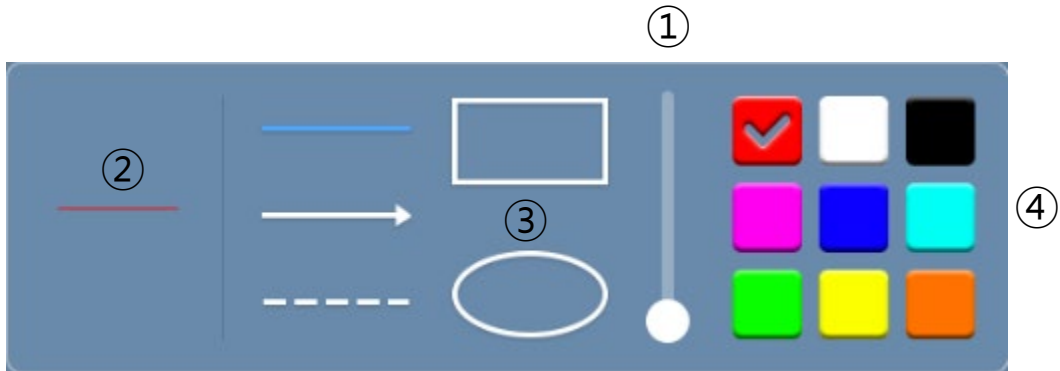

Option		Description
①	Line Weight	Move the slider to increase or decrease the thickness of the line.
②	Preview	You can preview the changes as you're making them.
③	Shape	Choose one of the preset shapes: circle, triangle, square, octagon. You can choose between shape outline or filled solid shape. Also 2 line options available: solid and dotted.
④	Color	Choose one of the 9 colors (red, white, black, purple, dark blue, sky blue, green, yellow, orange)

Operation issues

1. Handwriting is too thick

▶ Click the pen  icon and move the slider to reduce line weight.

2. Can't load a file







▶ Check if the file extension is *.zip

1) 2-point long touch : Execute the floating annotation.









Floating Annotation



Icon	Name	Description
	E-board	Switch to drawing program
	Capture	Screen Capture (Make .bmp file)
	Eraser	Delete selected object
	All Clear	Delete All
	Pen	Switch to Pen Menu
	Zoom in/out	Screen Zoom In and Zoom out(100%~400%)
	Exit	Close Annotation





Pen Menu



Icon	Name	Description
	Black color	Switch pen color to black
	Red color	Switch pen color to Red
	Blue color	Switch pen color to Blue
	thin Line	Switch line thickness to thin
	Middle Line	Switch line thickness to middle
	Thick Line	Switch line thickness to thick
	Back	Return to Annotation Menu

Zoom Menu



Icon	Name	Description
	Back	Return to Floating annotation menu
	Zoom in	Screen Zoom in (maximum 400%)
	Zoom out	Screen Zoom out (minimum 100%)
	Zoom 100%	Screen Zoom 100% / Return to normal size

6. Setup Menu Description

6.1 Menu Overview

Go to the Setup Menu through one of the following ways:

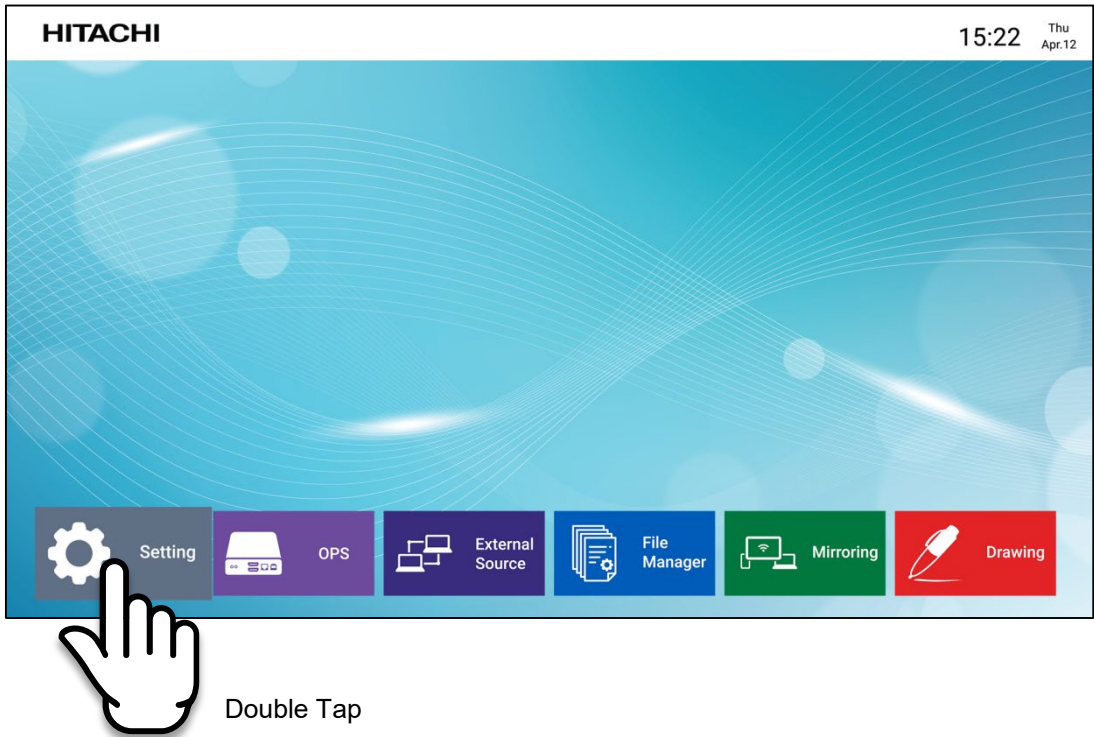

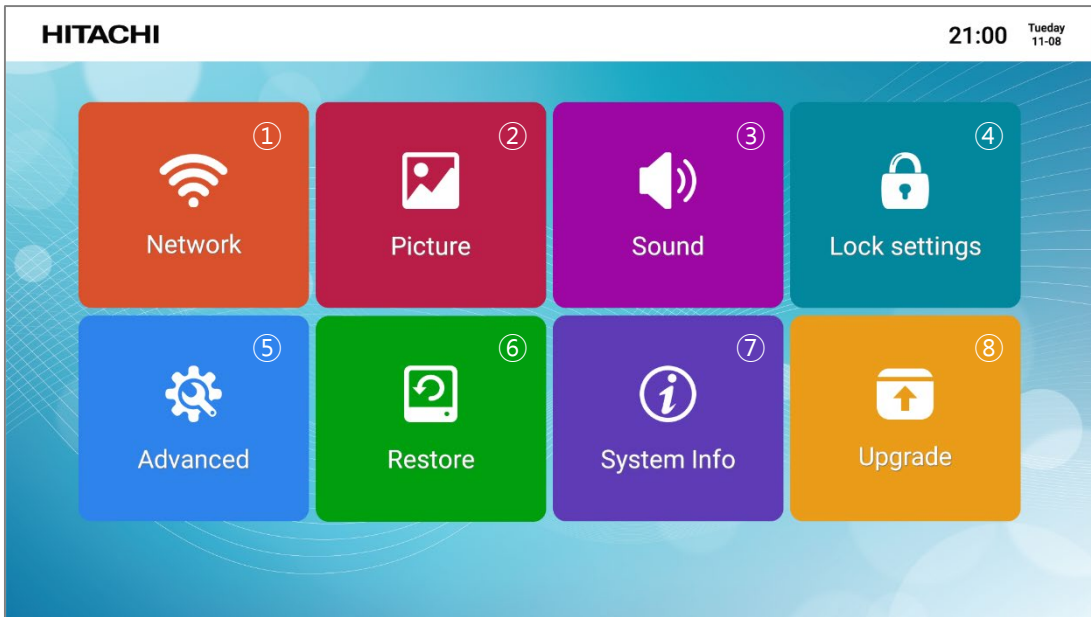

- ① Network: to setup up network connection
- ② Picture : to setup the Backlight mode
- ③ Sound : to setup the sound features
- ④ Lock settings : to setup the lock style, unlock password
- ⑤ Advanced : to setup Power option and background image
- ⑥ Restore : to reset the system
- ⑦ System info : to check the system information
- ⑧ Upgrade : to upgrade system F/W

6.2 Network

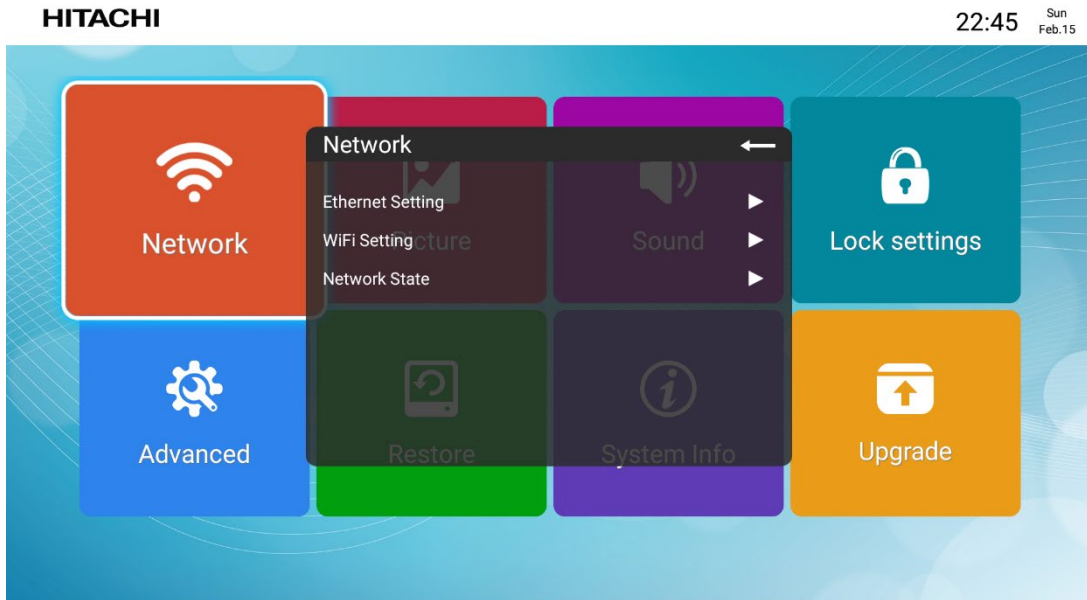

- Ethernet Setting
Set up detailed features of Ethernet.
- WiFi Setting
Set up detailed features of WiFi.
- Network State
Show network status.

6.3 Picture

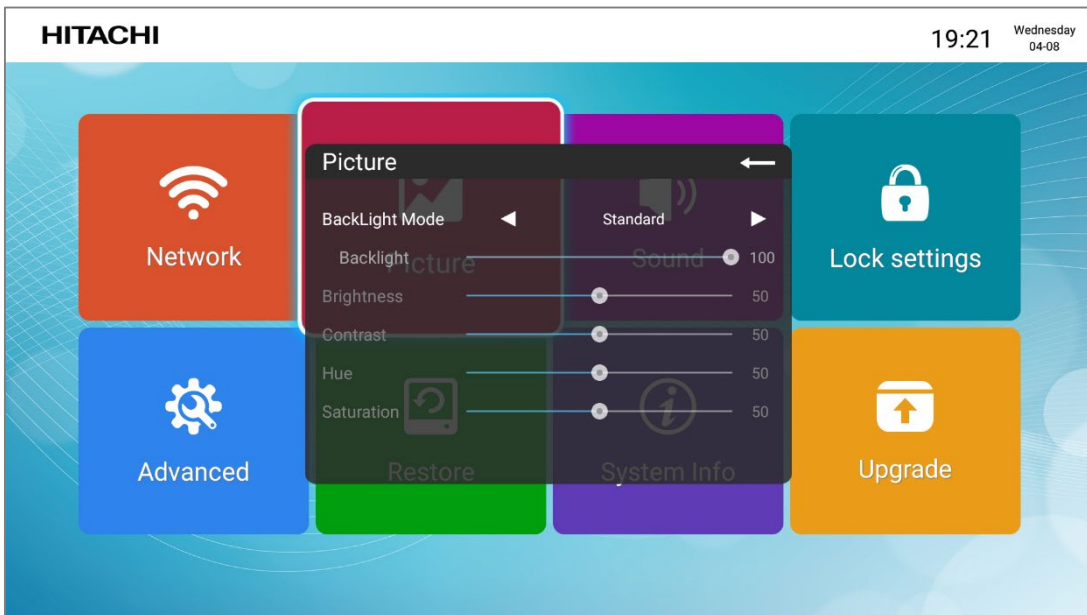

- Backlight Mode : User can set the Backlight Mode .There are Standard, Energy saver, Auto, and Custom Mode. Users can adjust each value in Custom Mode.
- Backlight : (less) 0 to 100 (more) of the Backlight

6.4 Sound

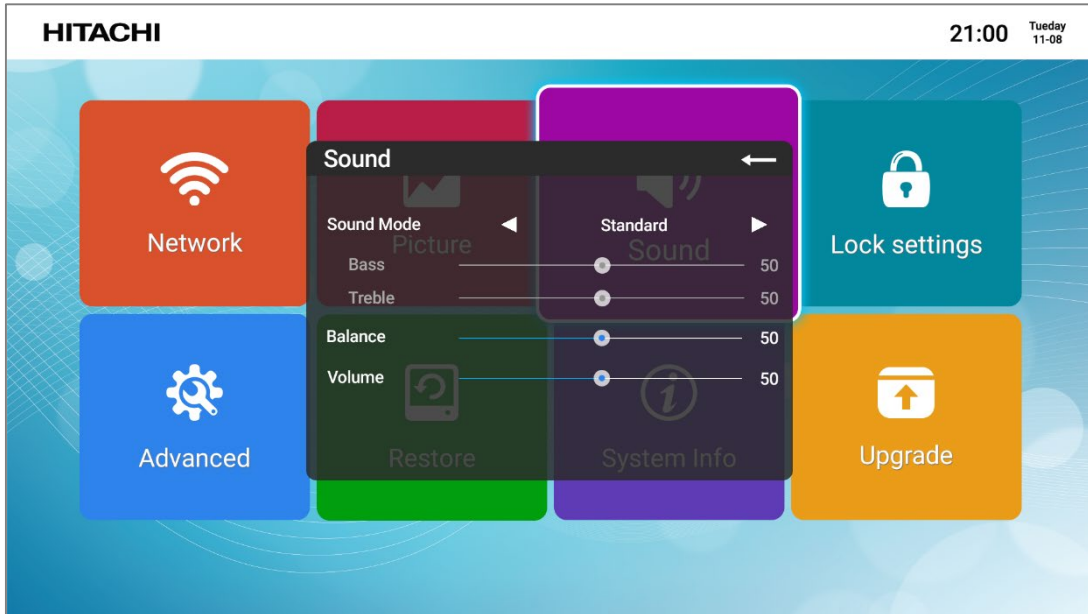

- Sound Mode : User can set the Sound Mode .There are Standard, Movie, Meeting, Classroom, Custom Mode. Users can adjust each value in Custom Mode:
 - Bass : (less) 0 to 100 (more) of bass sound
 - Treble : (less) 0 to 100 (more) of treble soundThese values can be changed in all modes:
 - Balance : (left) 0 to 100 (right) of the speaker volume balance
 - Volume : (less) 0 to 100 (more) of the volume

6.5 Lock Setting

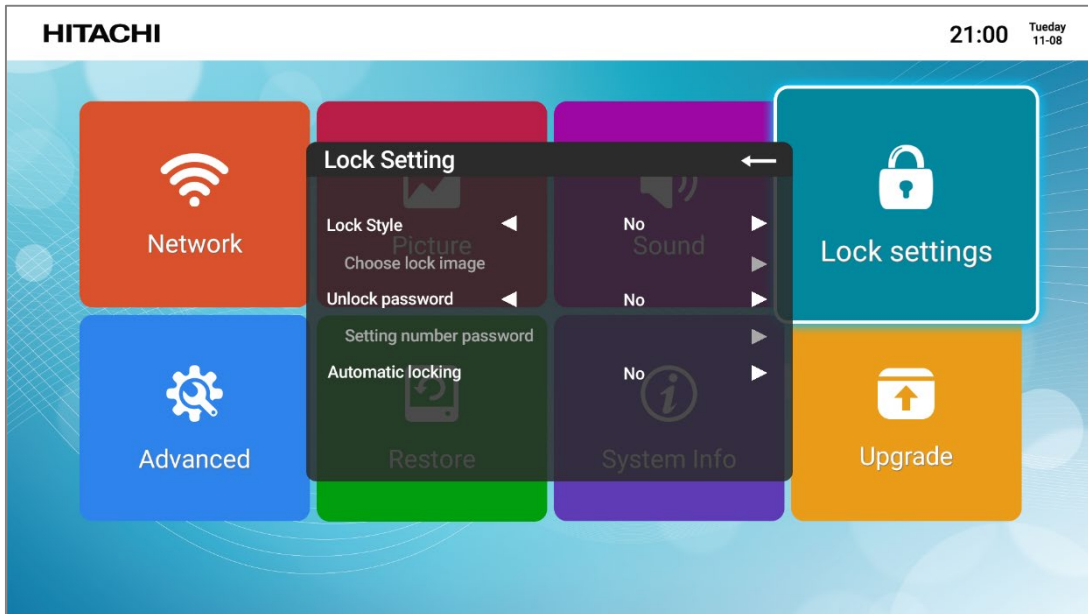

Lock Style: Through selecting the photo you want, you can configure the lock screen.

Unlock password: You can set a 4-digit password.

Automatic locking: You can set the time for the locked screen. (No, 10min, 15min, 30min, 45min, user defined)

6.6 Advanced

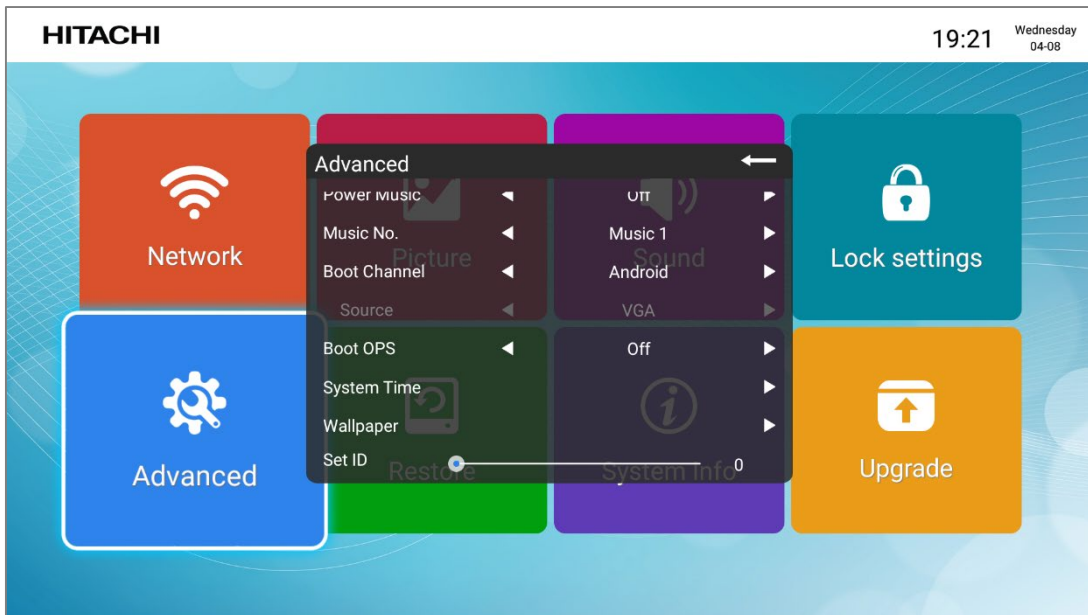
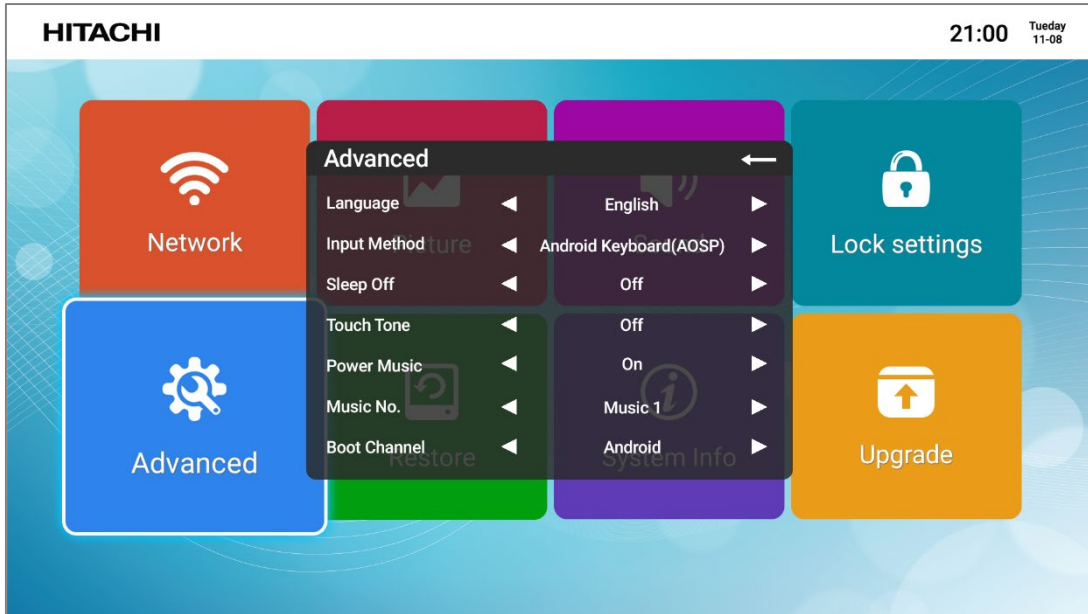

Advanced : to setup the advanced function.

- Language : User can set the OSD menu language.
- Input Method : User can set Keyboard type (AOSP and IME Type)
- Sleep Off : User can set time for automatic shutdown. (Off, 15, 30, 45, 60, 90, 120, 240 minutes)
- Touch Tone : User can set the touch sound (on/off)
- Power Music : User can set the sound when booting.
- Music No.: User can set the power music (Music 1, Music 2)
- Boot Channel : User can set the start screen when the system powers on.(Home, Force Input Source, Remember Input Source)
- Source : when select the Force Input Source, user can change the Source (VGA, OPS, EXTERNAL, HDMI 1, 2, 3, DP)
- Boot OPS : User can set up whether the OPS automatically powers on when the IFPD powers on.
- System Time : User can set up System time and date, time zone, etc.
- Wallpaper : User can set the wallpaper of the Home screen.
- Set ID : For RS232 communication, set ID from 0 to 99.

6.7 Restore

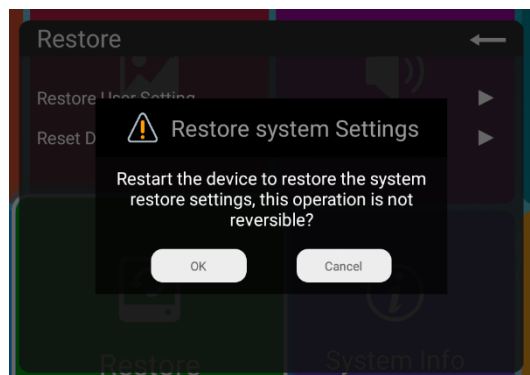
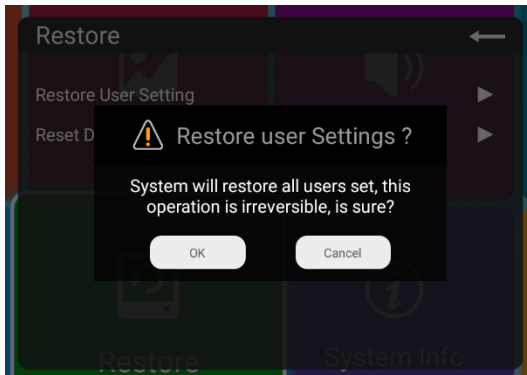
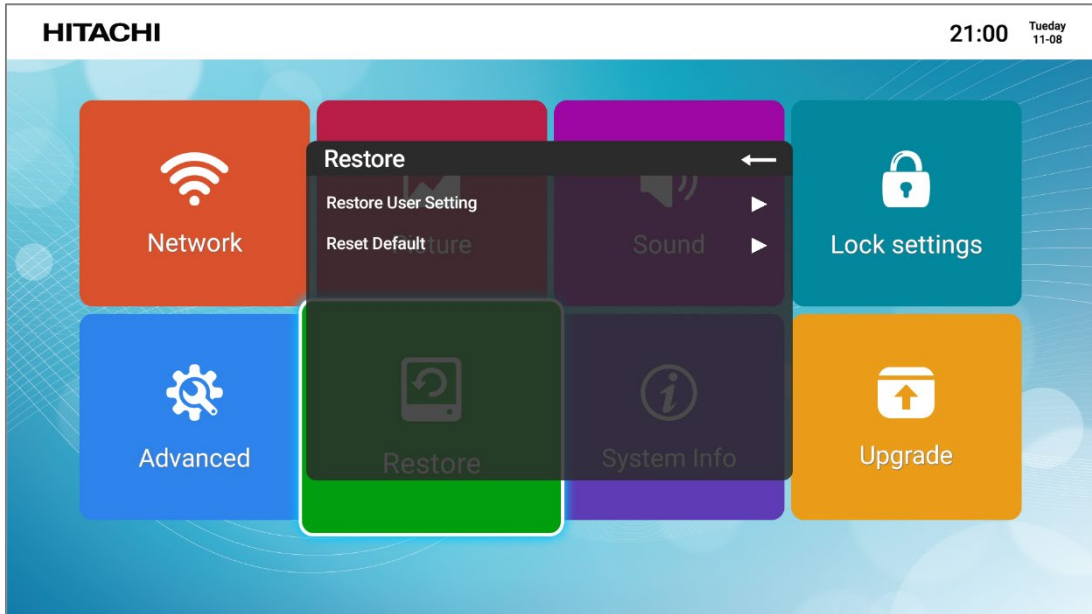

Restore : To reset the system

- Restore user Setting: to reset to user setting
- Restore Default : to reset to factory setting

6.8 System Info

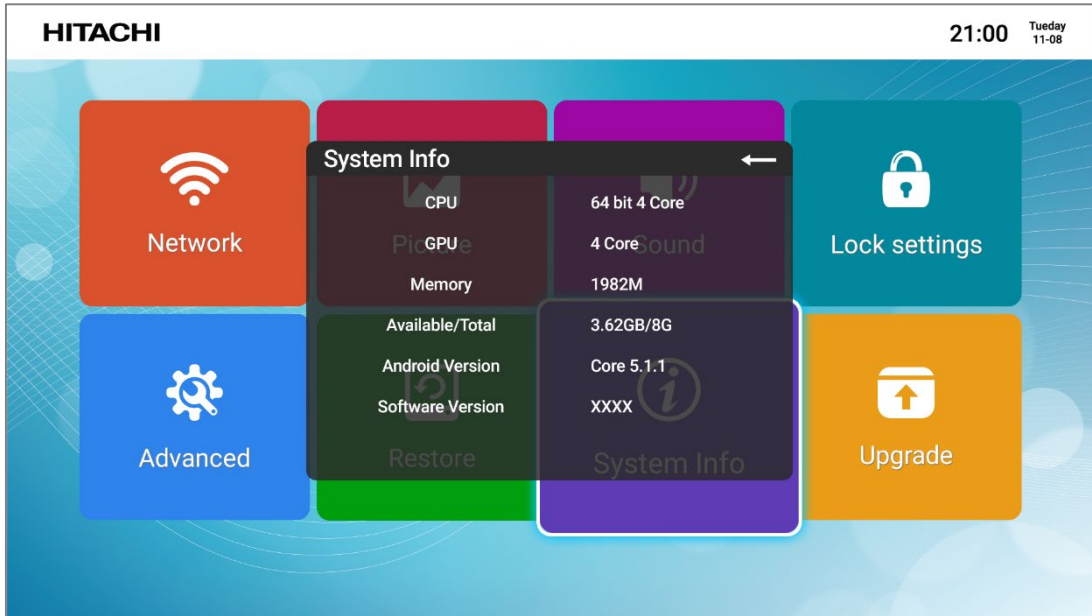

System Info :

To check the system information (CPU, GPU, Memory, Storage, Android Version and Software Version)

6.9 Upgrade

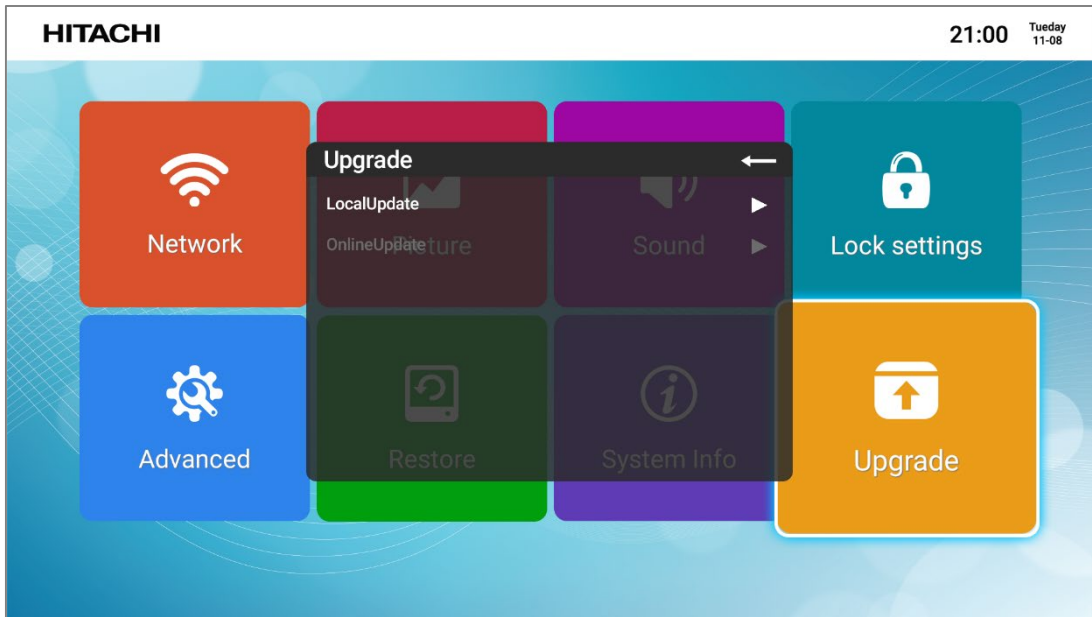

Local Update :

To upgrade F/W, insert the USB with the firmware on the back side "Bracket for F/W update" and then select Local Update.

7. Product Specification

LED PANEL			
Diagonal Size	85.60 "/217.4(cm)		
Display Resolution (Max.)	3840 x 2160 (UHD)		
Brightness (Average)	400cd/m ²		
Viewing Angle	H: 178° / V: 178°		
Contrast Ratio	1300:1 (Typ.)		
Supported Colors	1.07B Colors (10bit)		
Response Time	8 ms (GTG)		
Display Frame Rate	60Hz (Actual)		
Installation	Landscape Orientation		
TOUCH			
Detect Area	1895.04(H) x 1065.96(V) mm		
Detection Method	Infrared blocking detection method		
Touch Tool	Hand or other solid object(except sharpness)		
Accuracy	±2mm		
Response Time	1 ~ 14point : ≤10ms, 15 ~ 20 point : 10ms ~ 20ms		
Available Touch Point	20 Points (Windows)		
	4 Points (Mac with driver software)		
	1 Point (Mac without driver software)		
Operating Systems	Windows 7, 8, 10 / Mac 10.10-10.12		
PC Connector	USB		
SIGNAL CONNECTIVITY			
Connector	Front	HDMI x1	
		USB-B (for touch) x1	
		USB-A (2.0ver) x1	
	Rear	HDMI(2.0ver) x4 (Rear x3, Inside OPS x1)	
		DP x1	
		USB-B(for touch)x2	
		USB-A(2.0ver)x1	
		USB-A (3.0ver)x1	
		HDMI Out(HDMI Pass-Through)	
		VGA x1	
Audio Out / In	Speaker out (R/L) , Line out, VGA Audio in		
Communication Port	RS-232C (D-sub 9-pin) or LAN(RJ45)		
OPS Slot	1		

MECHANICAL	
Dimensions Landscape	1999 x 1226 x 117 mm
Weight	91 kg (200.7 lbs)
VESA Mount	600 x 400 (mm), M8 Screw
Front Glass	Tempered Glass 4.8t (Anti-glare Type)
SOFTWARE & MIRRORING	
PC-less writing	Yes-Windows, Mac
Annotation	Yes-Windows, Mac
Eshare(Screen mirroring)	Yes-Windows, Mac, Chrome, Android, iOS
ELECTRICAL	
Power Requirement	100 - 240V AC, 50/60 Hz
Power Consumption	450W
Power Consumption (Standby)	< 0.5W
Speaker Output	20W + 20W Stereo (8-ohms)
ENVIRONMENTAL	
Operating Temperature	0 ~ 40 °C (32 ~104 °F)
Storage Temperature	- 20 ~ 60 °C (-4 ~ 140 °F)
Operating Humidity	20% to 80% RH (no condensation)
OSD FUNCTIONS	
OSD Language Function	English / Français / Deutsch / Spanish / Português / Italiano / Danish / Swedish / Norwegian / Suomi / Russian / Polish /Turkish / Hungarian / Chesky / Korean / Japanese / Chinese / Greek / Dutch / Arabic
OSD Key Lock Function	Support

8. Product Dimensions

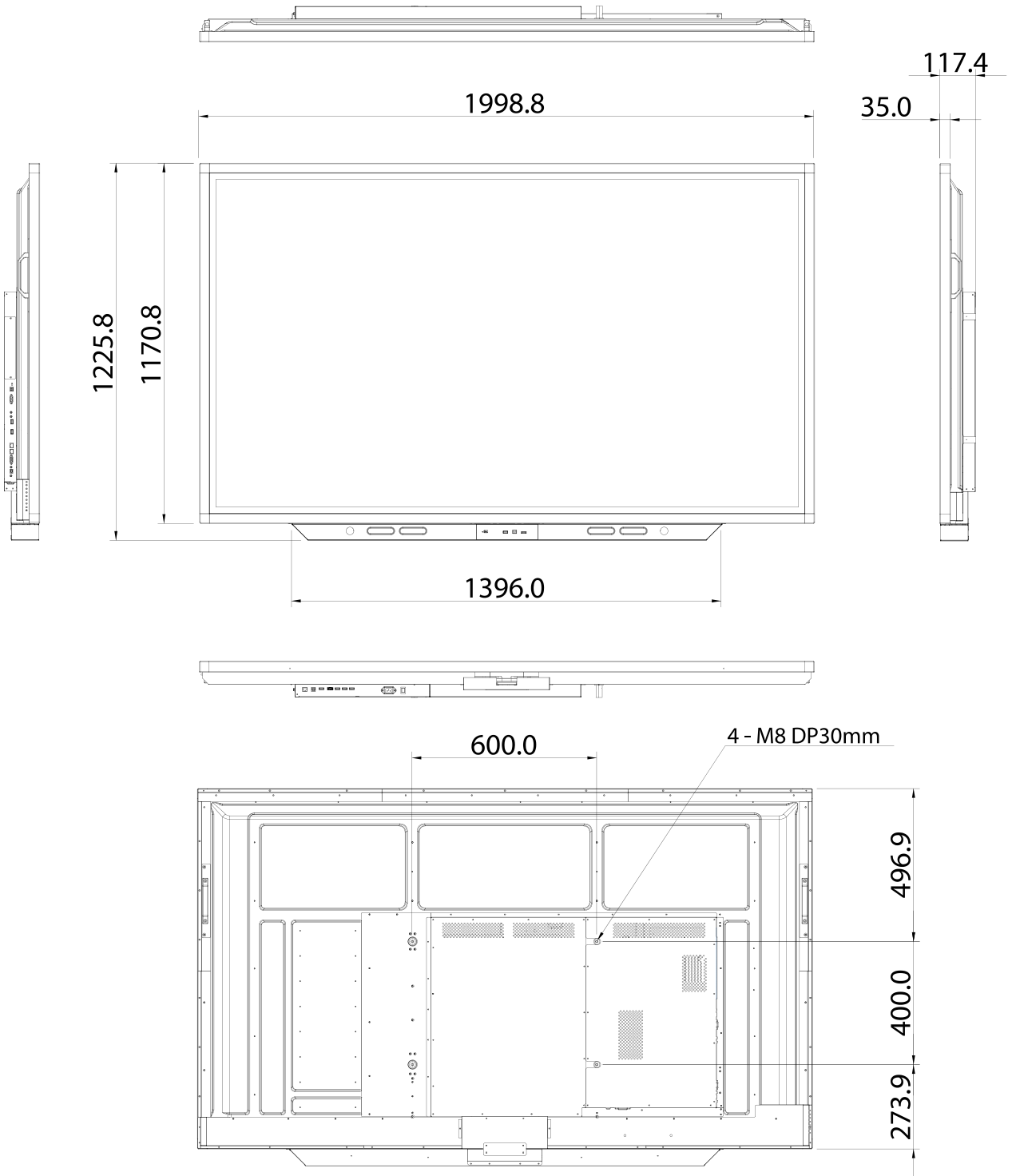

9. Troubleshooting

9-1. Product Self-Diagnosis

- You can check if the product is working properly using the Self-Diagnosis function.
- If a blank screen is displayed and the Power LED blinks even if the product and the PC are properly connected, perform the self-diagnosis function according to the procedures below.
Turn the product and the PC off.
Remove the D-Sub cable from the product.
Turn the product on.
If the product is working properly, the <Check Signal Cable> message appears.
In this case, if a blank screen is displayed again, make sure that there is no problem with the PC and the connection.

9-2 Before Requesting Service

- Please check the following before requesting After-Sales service.
If the problem continues, please contact your nearest Service Center.

1) PROBLEMS RELATED TO SCREEN.

1. Screen is blank and power indicator is off.
 - » Ensure that the power cord is firmly connected and the monitor is on.
2. <Mode Not Supported> Message.
 - » Check the maximum resolution and the frequency of the video adapter.
 - » Compare these values with the data in the Standard Signal Mode Table.
3. Picture rolls vertically.
 - » Check if the signal cable is securely connected. Connect it again securely.
4. Image is not clear. Picture is blurred.
 - » Run frequency<Coarse> and <Fine> tuning.
 - » Turn on again after removing all accessories(video extension cable, etc.) Set resolution and frequency to the recommended ranges.
5. The image is too light or too dark.
 - » Adjust the <Brightness>and<Contrast>.
6. Screen is blank and the power indicator light blinks every 0.5 or 1 seconds.
 - » The monitor is using its power management system. Press a key on the keyboard.

2) PROBLEMS RELATED TO AUDIO.

1. No sound
 - » Ensure that the audio cable is firmly connected to both the audio-in port on your monitor and the audio-out port on your sound card.
2. The sound level is too low.
 - » Check the volume level. If the volume is still too low after turning the control to its maximum, check the volume control on the computer sound card or software program.

3. PROBLEMS RELATED TO REMOTE CONTROL.

4. The remote control buttons do not respond.
 - » Check the battery polarities(+/-).
 - » Check if the batteries have been exhausted.
 - » Check if the power is on.
 - » Check if the power cord is securely connected.
 - » Check if a special fluorescent or neon lamp is on in the vicinity.

10. History

Date	Corrections
2018.11.22	<p>p13 RS232C/RJ45 SWITCH ==> RJ45/RS232C SWITCH</p> <p>p16 Setting > Advance Setting > RS232C/RJ45 select ==>Delete</p> <p>P16 Add==>How to select RS232C On/Off switch RJ45(↑), RS232C(↓)</p> <p>p46 RS232C/RJ45 : Choose the desired connection. ==>Delete</p>
2018.11.30	<p>P46 (VGA, OPS, EXTERNAL, HDMI 1, 2, 3, DP,AV, YPBR) ==>(VGA, OPS, EXTERNAL, HDMI 1, 2, 3, DP)</p>