

# HITACHI

Inspire the Next



## **DS75MU01**

User Manual (English)



## 1. Important Safety instructions

### [SAFETY WARNING]

- To reduce the risk of fire or electric shock, do not expose this product to rain or moisture.
- To prevent injury, this product must be securely attached to the floor/wall in accordance with the installation instructions.
- To reduce the risk of electric shock, do not remove the back cover
- Refer to qualified service personnel if needed.

### Icons used in this manual

	<b>CAUTION</b> RISK OF ELECTRIC SHOCK. DO NOT OPEN.			The lightning flash and arrowhead within the triangle indicates that there is dangerous voltage inside the product.
				The exclamation point within the triangle indicates that there are important instructions accompanying the product.

[WARNING] means,

If you ignore the warning message, you may be seriously injured or there is a possibility of accident or death.

[CAUTION] means,

If you ignore the caution message, you may be slightly injured or the product may be damaged.

[NOTE] means,

The note helps you understand and use the product safely. Please read the note carefully before using the product.

### Warning:

This equipment is compliant with Class A of EN55032/CISPR 32. In a residential environment this equipment may cause radio interference.

When moving the product, please grab the handles behind and the bottom of the product as shown below picture.

- The product must keep horizontal and upright position when moving.
- Do not hold the corner of the product when you grab the bottom of the product.

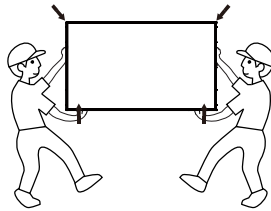

## 1.1. SAFETY PRECAUTION

**Note:** The color and design may differ by each model and the product specification are subject to change without notice for performance enhancement.

### 1.1.1. Power

#### [Warning]

- Do not use damaged power cord, plug nor loose socket. It may cause electric shock or fire.
- Do not connect multiple devices into a single socket. It may cause fire due to overheating.
- Do not touch with wet hands when remove or plug the power cord to avoid electric shock.
- Insert the power plug into socket firmly. It may cause fire when the connections are unstable.
- Connect the power cord to a grounded wall socket. There is risk of electric shock or injury.
- Do not bend nor pull the power cord and place heavy objects over the power cord. It may occur cord damage and this may result in fire.
- Please clean only with dry cloth when the plug pin or socket are dusty. It may cause fire.

#### [Caution]

- Do not unplug the power plug while the product is operating. It may damage the product due to electric shock.
- Only a power cord specified by product manufacturer are recommended.
- Do not use the power cord from other devices. It may cause electric shock or fire.
- Hold the plug itself when unplugging the power plug from the wall socket. If not, there is risk of electric shock or fire.
- Before moving or installing this product, be sure to turn off the power and disconnect the power cord. To turn this product off completely, you must pull the power plug out of the wall socket. Consequently, the power plug must be easily and readily accessible at all times.
- The AC inlet and MAIN Power Switch are disconnect device, the location on the apparatus and the function of the switch shall be described, and the switch shall remain readily operable.

### 1.1.2. Installation

#### [Warning]

- Do not install near any heat sources such as radiators, or other devices that produce heat. It may cause electric shock or fire.
- When mounting a product on the wall, make sure not to install the product by hanging the power and signal cables on the back of it.
- Consult with your local dealer or specialized engineer to mount the product on the wall, and use the screws and wall mounts that meet the VESA standard. Any damages or injuries by misuse or using an improper accessory are not covered by the warranty.
- Leave a 10 cm (4 inches) (minimum) space from the wall for proper ventilation. If not, it may cause fire.
- Keep the packing anti-moisture material or vinyl packing out of the reach of children. Anti-moisture material is harmful if swallowed. If swallowed by mistake, force the patient to vomit and visit the nearest hospital. Additionally, vinyl packing can cause suffocation. Keep it out of the reach of children.
- Please note that the product must be supported on proper stands or installed according to the manufacturer's recommendations. The product that are inappropriately situated on unstable shelves, inclined planes, or vibrating places, etc., may fall over, resulting in injury.
- To reduce the risk of fire or electrical shock, do not expose this product to rain, moisture or other liquids or dust. It may cause electric shock or fire.
- Keep the product away from direct sunlight.
- Keep the product out of the reach of children and install on the stable and flat place. NEVER allow children to climb on or play on the product or the furniture and stands on which the product is placed.

**[Caution]**

- Do not allow an impact shock or any objects to fall into the product, and do not drop anything onto the screen.
- Make sure the product is turned off, unplugged, and all cables have been removed. It may take more than 4 people to than carry.
- Do not press or put stress on the front panel of the product.
- If the product is installed in a place where the operating conditions considerably, a serious quality problem may occur due to the surrounding environment. In this case, install the product only after consulting our dealer about the matter. (Places exposed to microscopic dust, chemicals, too high or low temperature, high humidity, airports or stations where the product is continuously used.)

**1.1.3. Cleaning****[Warning]**

- Before cleaning the product, unplug the power cord and wipe gently with a soft cloth to prevent scratching.
- Do not spray water or other liquids directly on the product as electric shock may occur.

**[Caution]**

- Do not push, rub, or hit the surface with your fingernail or a sharp object, as this may result in scratches on the screen and image distortions.
- Do not use any chemicals, such as waxes, benzene, alcohol, thinners, insecticides, air fresheners, or lubricants, as these may damage the screen's finish and cause discoloration.
- Do not spray liquid onto the surface. If water enters the product, it may result in fire, electric shock, or malfunction.

**1.1.4. General Usage****[Warning]**

- To reduce the risk of electric shock, do not open the cover or back. No user serviceable parts inside. Refer to qualified service personnel.
- Before moving or lifting the product, disconnect the power cord and all cables.
- The route cords and cables connected to the product so that they cannot be tripped over, pulled or grabbed.
- Do not stick metal objects or any other conductive material into the power cord. Do not touch the end of the power cord while it is plugged in. It may result in fire, electric shock.
- Unplug this product during lightning storms or when unused for long periods of time.
- Do not block any ventilation openings. Install in accordance with the manufacturer's instructions.
- To reduce the risk of fire or electrical shock, do not expose this product to rain, moisture or other liquids. Do not touch the product with wet hands. Do not install this product near flammable objects such as gasoline or candles, or expose to direct air conditioning.
- NEVER allow children to climb on or play on the product or the furniture on which it is placed. It may cause severe injury to children.
- Use only with a cart, stand, tripod, bracket, or table specified by the manufacturer, or sold with the product. When a cart is used, be careful when moving the cart/product combination to avoid injury from tip-over.
- Install where it cannot be pushed, pulled over or knocked down.
- It is recommended to move the product in the box or packing material that originally came in.
- When holding the product, the screen should face away from you to avoid damage.

**[Caution]**

- If a fixed image displays on the screen for a long period of time, it will be imprinted and become a permanent disfigurement on the screen. This is image burn or burn-in and not covered by the warranty.
- Avoid displaying a fixed image on the screen for a long period of time to prevent image burn. Recommend to power off or set the screen saver mode when not in use. Be aware that the image burn symptom cannot be repaired and is not covered under warranty.
- When watching the screen, take 5 to 15 minute breaks every hour. Viewing screen for a long period of time may cause fatigue or eye strain.

## DS75MU01

- Take care not to touch the ventilation openings. When watching the screen for a long period, the ventilation openings may become hot. This does not affect the performance of the product or cause defects in the product.
- Do not install this product on a wall if it could be exposed to oil or oil mist. This may damage the product and cause it to fall.
- To install batteries in remote control, open the battery cover, replace batteries matching (+) and (-) ends to the label inside the compartment, and close the battery cover. Failure to match the correct polarities of the battery may cause the battery to burst or leak, resulting in fire, personal injury, or ambient pollution.
- To prevent to swallow the small accessories for children, keep the accessories out of the reach of children.
- The product must keep horizontal and upright position when moving. Hold the top and bottom of the frame firmly.
- When attaching the wall mount to the set, place the screen facing down on a cushioned table or flat surface to protect the screen from scratches by more than 2 people.
- Make sure that the screws are fastened tightly. (If they are not fastened securely enough, it may tilt forward after being installed.)

### 1.2. MAINTENANCE

#### 1.2.1. Cleaning

[Warning]

- When cleaning, unplug the power cord and wipe gently with a soft dry cloth to prevent scratching.
- Do not spray water or other liquids directly on the screen as electric shock may occur.
- Do not clean with chemicals such as alcohol, thinners, or benzene.

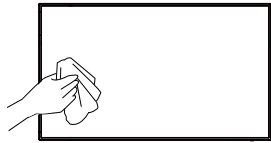

#### 1.2.2. Installation

- Leave a 10 cm (4 inches) (minimum) space from the wall for proper ventilation. If not, it may cause fire or malfunction due to the high temperature product inside.

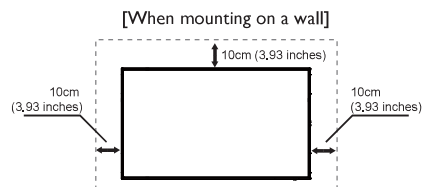

#### 1.2.3. Panel

- Avoid displaying a fixed image on the screen for a long period of time (2 or more hours for LCD) to prevent image burn. Recommend to power off or set the power saving mode or screen saver when not in use.
- Due to technological constraints of the Panel manufacturer, the images generated by this product may appear either brighter or darker than normal by appr. 1ppm (parts per million) pixel.
- The number of sub-pixels of a panel by size: The number of Sub-Pixels = Max. Horizontal Resolution x Max. Vertical Resolution x 3.
- For example, if the maximum resolution is 3840 x 2160, the number of sub-pixels is 1920 x 1080 x 3 = 12,441,600.

## Table Of Contents

<b>1. Unpacking and Installation.....1</b>	5.10. Date & time.....28
1.1. Unpacking .....1	5.11. Developer options.....28
1.2. Package Contents.....1	5.12. About.....28
1.3. Installation Notes.....1	5.13. Supplementary.....29
1.4. Mounting on a Wall.....2	<b>6. OSD Menu.....31</b>
<b>2. Parts and Functions.....3</b>	6.1. Navigating the OSD Menu.....31
2.1. Control Panel.....3	6.2. OSD Menu Overview.....31
2.2. Input/Output Terminals .....4	<b>7. Supported Media Formats.....38</b>
2.3. Remote Control.....6	<b>8. Input Mode.....40</b>
<b>3. Connecting External Equipment.....9</b>	<b>9. Cleaning and Troubleshooting 42</b>
3.1. Connecting External Equipment (DVD/CR/VCD) .....9	9.1. Cleaning .....42
3.2. Connecting a PC.....9	9.2. Troubleshooting.....43
3.3. Connecting Audio Equipment10	<b>10. Technical Specifications.....45</b>
3.4. Connecting Multiple Displays in a Daisy-chain Configuration..10	
3.5. IR connection.....11	
3.6. IR Pass-through Connection.11	
<b>4. Operation.....12</b>	
4.1. Watch the Connected Video Source .....12	
4.2. Change Picture Format.....12	
4.3. Overview .....12	
4.4. Media Player introduction:.....13	
4.5. Browser manual.....14	
4.6. PDF reader play.....16	
4.7. CMS.....18	
<b>5. Signage display.....18</b>	
5.1. Setting .....18	
5.2. Ethernet .....18	
5.3. Proxy.....19	
5.4. Signage Display.....19	
5.5. System Tools .....26	
5.6. Clone Media File .....27	
5.7. Display .....28	
5.8. Apps.....28	
5.9. Security.....28	

## 1. Unpacking and Installation

### 1.1. Unpacking

- This product is packed in a carton, together with the standard accessories.
- Any other optional accessories will be packed separately.
- Due to the size and weight of this display it is recommended for two people to move it.
- After opening the carton, ensure that the contents are complete and in good condition.

### 1.2. Package Contents

Please verify that you received the following items with your package content:

- LCD display
- User Manual
- Warranty Card
- Remote control and AAA Batteries
- Power Cord
- RS232 Cable
- RS232 Daisy Chain Cable
- HDMI Cable

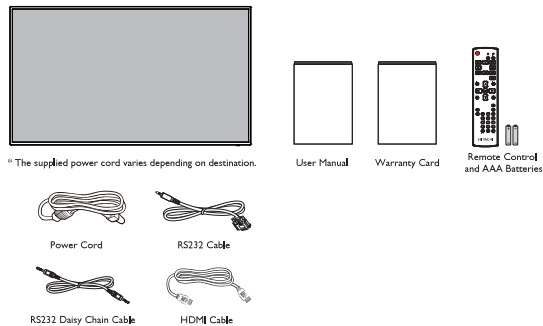

#### NOTES:

- For all other regions, apply a power cord that conforms to the AC voltage of the power socket and has been approved by and complies with the safety regulations of the particular country (Type H05W-F, 2G or 3G, 0.75 or 1 mm<sup>2</sup> should be used).
- You might like to save the package box and packing material for shipping the display.

### 1.3. Installation Notes

- Due to the high power consumption, always use the plug exclusively designed for this product. If an extended line is required, please consult your service agent.
- The product should be installed on a flat surface to avoid tipping. The distance between the back of the product and the wall should be maintained for proper ventilation. Avoid installing the product in the kitchen, bathroom or any other places with high humidity so as not to shorten the service life of the electronic components.
- The product can normally operate only under 3000m in altitude. In installations at altitudes above 3000m, some abnormalities may be experienced.



### 1.4. Mounting on a Wall

To mount this display to a wall, you will have to obtain a standard wall-mounting kit (commercially available). We recommend using a mounting interface that complies with TUV-GS and/or UL1678 standard in North America.

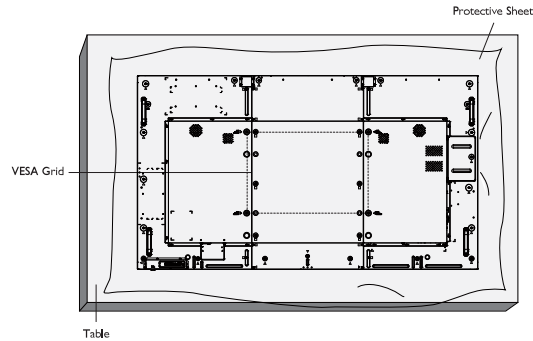

1. Lay a protective sheet on a table, which was wrapped around the display when it was packaged, beneath the screen surface so as not to scratch the screen face.
2. Ensure you have all accessories for mounting this display (wall mount, ceiling mount, table stand, etc).
3. Follow the instructions that come with the base mounting kit. Failure to follow correct mounting procedures could result in damage to the equipment or injury to the user or installer. Product warranty does not cover damage caused by improper installation.
4. For the wall-mounting kit, use M6 mounting screws (having a length 10 mm longer than the thickness of the mounting bracket) and tighten them securely.
5. Unit without base weight= 53,3 kg. The equipment and its associated mounting means still remain secure during the test. For use only with UL Listed Wall Mount Bracket with minimum weight/load: 53,3 kg.
6. Portrait is not allowed.

#### 1.4.1. VESA Grid

<b>DS75MU01</b>	600(H) x 400(V) mm
-----------------	--------------------

#### Caution:

To prevent the display from falling:

- For wall or ceiling installation, we recommend installing the display with metal brackets which are commercially available. For detailed installation instructions, refer to the guide received with the respective bracket.
- To lessen the probability of injury and damage resulting from fall of the display in case of earthquake or other natural disaster, be sure to consult the bracket manufacturer for installation location.

#### Ventilation Requirements for enclosure locating

To allow heat to disperse, leave space between surrounding objects as shown in the diagram below.

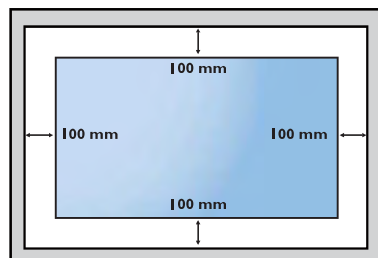

## 2. Parts and Functions

### 2.1. Control Panel

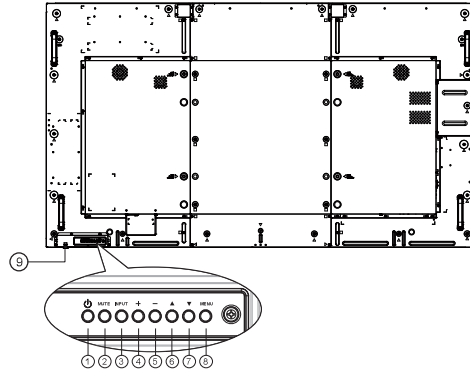

#### ① [⏻] button

Use this button to turn the display on or put the display to standby.

#### ② [MUTE] button

Switch the audio mute ON/OFF.

#### ③ [INPUT] button

Choose the input source.

#### ④ [⏏] button

- Increase the volume
- Enter into submenu while OSD menu is on

#### ⑤ [⏏] button

- Decrease the volume
- Back to previous menu while OSD menu is on

#### ⑥ [▲] button

- Move the highlight bar up to adjust the selected item while OSD menu is on
- Increase the adjustment while adjust value.

#### ⑦ [▼] button

- Move the highlight bar down to adjust the selected item while OSD menu is on.
- Decrease the adjustment while adjust value.

#### ⑧ [MENU] button

Return to previous menu while OSD menu is on, or to activate the OSD menu when OSD menu is off.

#### ⑨ Remote control sensor and power status indicator

- Receives command signals from the remote control.
- Indicates the operating status of the display without OPS:
  - Lights green when the display is turned on
  - Lights red when the display is in standby mode
  - When {SCHEDULE} is enabled, the light blinks green and red
  - If the light blinks red, it indicates that a failure has been detected
  - Lights off when the main power of the display is turned off

\* Using IR sensor cable for better remote control performance. (Please refer to the instructions of 3.5)

## 2.2. Input/Output Terminals

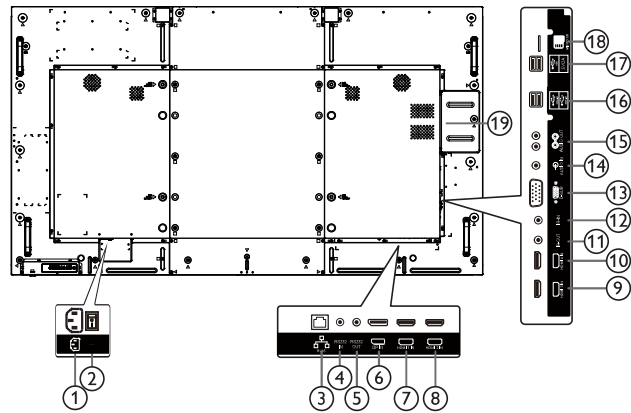

- ① **AC IN**  
AC power input from the wall outlet.
- ② **MAIN POWER SWITCH**  
Switch the main power on/off.
- ③ **RJ-45**  
LAN control function for the use of remote control signal from control center, and internal function.
- ④ **RS232C IN / ⑤ RS232C OUT**  
RS232C network input / output for the loop-through function.
- ⑥ **DisplayPort IN**  
DisplayPort video input.
- ⑦ **HDMI1 IN / ⑧ HDMI2 IN / ⑨ HDMI1 IN /**
- ⑩ **HDMI2 IN**  
HDMI video/audio input.
- ⑪ **IR OUT / ⑫ IR IN**  
IR signal input / output for the loop-through function.
- NOTES:
- This display's remote control sensor will stop working if the jack [IR IN] is connected.
  - To remotely control your A/V device via this display, refer to page 14 for or IR Pass Through connection.
- ⑬ **VGA IN (D-Sub)**  
VGA video input.
- ⑭ **PC LINE IN**  
Audio input for VGA source (3.5mm stereo phone).
- ⑮ **AUDIO OUT**  
Audio output to external AV device.
- ⑯ **USB PORT**  
Connect your USB storage device.
- ⑰ **USB PORT A**
- 
- ⑱ **MICRO SD CARD**  
Connect your MICRO SD CARD.
- ⑲ **SECURITY LOCK**  
Used for security and theft prevention.

### 2.2.1. Inserting the batteries in the remote control

The remote control is powered by two 1.5V AAA batteries.

To install or replace batteries:

1. Press and then slide the cover to open it.
2. Align the batteries according to the (+) and (-) indications inside the battery compartment.
3. Replace the cover.

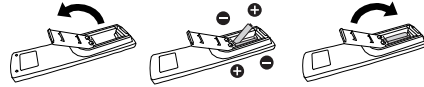

#### Caution:

The incorrect use of batteries can result in leaks or bursting. Be sure to follow these instructions:

- Place "AAA" batteries matching the (+) and (-) signs on each battery to the (+) and (-) signs of the battery compartment.
- Do not mix battery types.
- Do not combine new batteries with used ones. It causes shorter life or leakage of batteries.
- Remove the dead batteries immediately to prevent them from liquid leaking in the battery compartment. Don't touch exposed battery acid, as it can damage your skin.

NOTE: If you do not intend to use the remote control for a long period, remove the batteries.

### 2.2.2. Handling the remote control

- Do not subject to strong shock.
- Do not allow water or other liquid to splash the remote control. If the remote control gets wet, wipe it dry immediately.
- Avoid exposure to heat and steam.
- Other than to install the batteries, do not open the remote control.

### 2.2.3. Operating range of the remote control

Point the top of the remote control toward the display's remote control sensor when pressing a button.

Use the remote control within a distance of less than 5m/16ft from the display's sensor; and a horizontal and vertical angle of less than 30 degrees.

NOTE: The remote control may not function properly when the remote control sensor on the display is under direct sunlight or strong illumination, or when there is an obstacle in the path of signal transmission,

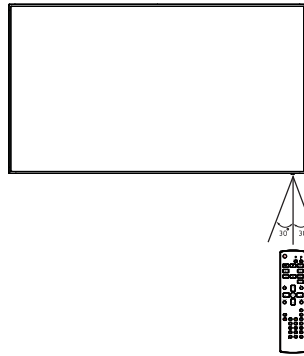



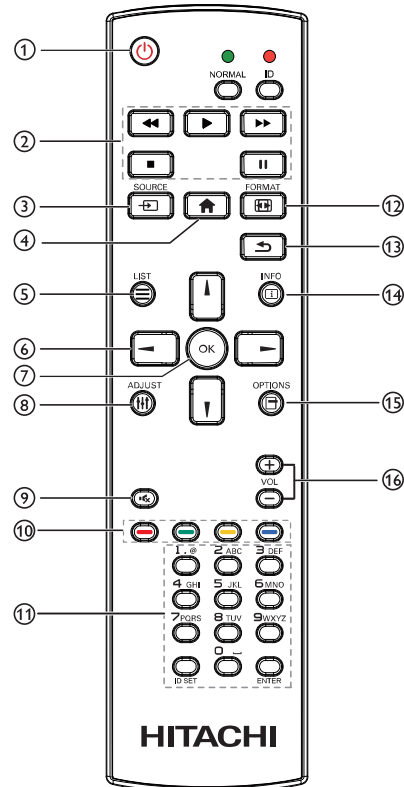

**2.3. Remote Control**

**2.3.1. General functions**



- ① **[POWER] POWER button**  
Power ON/OFF.
- ② **[PLAY] buttons**  
Control playback of media files.(for Media Input only)  
Freeze feature  
Pause: Freeze hot key for all inputs content,  
Play: Unfreeze hot key for all input content,
- ③ **[SOURCE] SOURCE button**  
Root Menu: Go to Video source OSD.
- ④ **[HOME] HOME button**  
Root Menu: Go to Main Menu OSD.  
Others: Exit OSD,

- ⑤ **[LIST] LIST button**  
No function,
- ⑥ **NAVIGATION buttons**  
  - [▲] Root Menu:** Go to Smart picture OSD.
  - Main Menu:** Move the highlight bar up to adjust the selected item.
  - IR Daisy Chain Menu:** Increase controlled Group ID number;
  - [▼] Root Menu:** Go to Audio source OSD.
  - Main Menu:** Move the highlight bar down to adjust the selected item.
  - IR Daisy Chain Menu:** Decrease controlled Group ID number;
  - [◀] Main Menu:** go to previous level menu.
  - Source Menu:** Exit source menu.
  - Volume Menu:** Decrease Audio Volume.
  - [▶] Main Menu:** go to next level menu or set selected option.
  - Source Menu:** Go to selected source.
  - Volume Menu:** Increase Audio Volume.
- ⑦ **[OK] button**  
Root Menu: Go to IR daisy chain OSD in Primary/ Secondary mode.  
Main Menu: Confirm an entry or selection.
- ⑧ **[ADJUST] ADJUST button**  
Go to Auto Adjust OSD for VGA only,
- ⑨ **[MUTE] MUTE button**  
Toggle Audio Mute/Unmute.
- ⑩ **[COLOR] buttons**  
No function.
- ⑪ **[Number/ ID SET/ ENTER] button**  
Enter text for network setting.  
Press to set the display ID, Refer to **2.3.2. ID Remote Control** for more detail.

- ⑫  **FORMAT button**  
Change Image Zoom Mode [Full][4:3][Real]  
[21:9][Custom].
- ⑬  **BACK button**  
Return to the previous menu page or exit from  
the previous function.
- ⑭  **INFO button**  
Show Information OSD
- ⑮  **OPTIONS button**  
No function.
- ⑯  **VOLUME button**  
Adjust volume.

### 2.3.2. ID Remote Control

You can set the remote control ID when you want to use this remote control on one of several different displays.

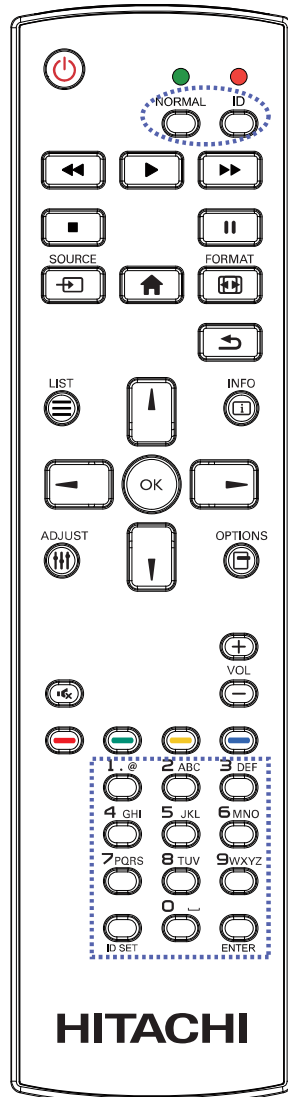

Press [**ID**] button, The red LED blinks twice.

1. Press [**ID SET**] button for more than 1 second to enter the ID Mode. The red LED lights up. Press the [**ID SET**] button again will exit the ID Mode. The red LED lights off.

Press the digit numbers [**0**] ~ [**9**] to select the display you want to control.

For example: press [**0**] and [**1**] for display No.1, press [**1**] and [**1**] for display No.11.

The numbers available are from [**01**] ~ [**255**].

2. Not pressing any button within 10 seconds will exit the ID Mode.
3. If an error pressing of buttons other than the digits occurred, wait 1 second after the red LED lights off and then lights up again, then press the correct digits again.
4. Press [**ENTER**] button to confirm, The red LED blinks twice and then lights off.

#### NOTE:

- Press [**NORMAL**] button. The green LED blinks twice, indicating the display is in normal operation.
- It is necessary to set up the ID number for each display before selecting its ID number.

### 3. Connecting External Equipment

#### 3.1. Connecting External Equipment (DVD/VCR/VCD)

##### 3.1.1. Using HDMI video input

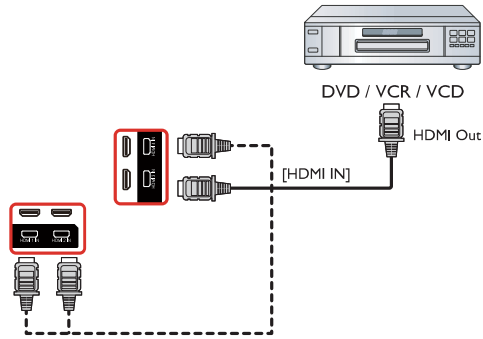

##### 3.2. Connecting a PC

###### 3.2.1. Using VGA input

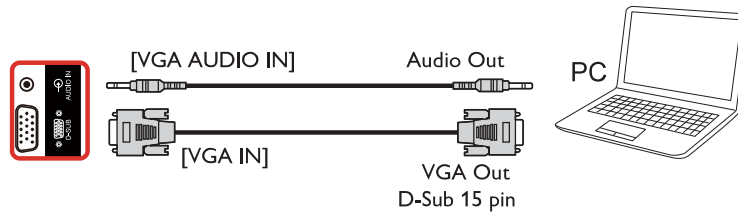

###### 3.2.2. Using HDMI input

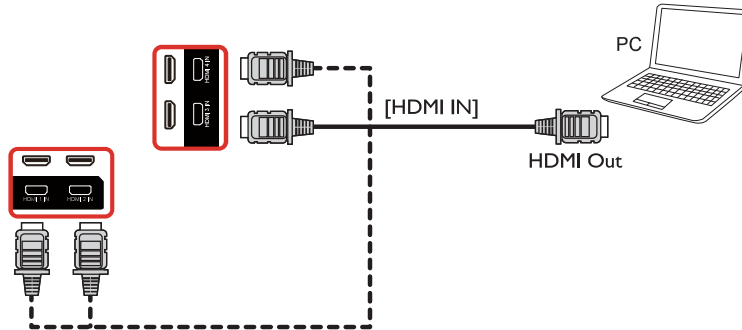



### 3.2.3. Using DisplayPort input

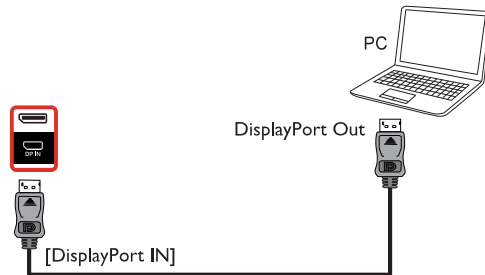

### 3.3. Connecting Audio Equipment

#### 3.3.1. Connecting an external audio device

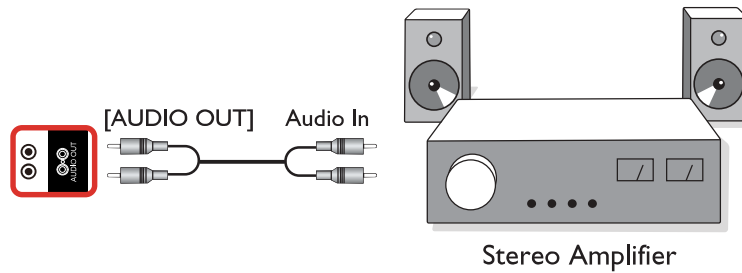

### 3.4. Connecting Multiple Displays in a Daisy-chain Configuration

You can interconnect multiple displays to create a daisy-chain configuration for applications such as a menu board.

#### 3.4.1. Display control connection

Connect the [RS232 OUT] connector of DISPLAY 1 to the [RS232 IN] connector of DISPLAY 2.

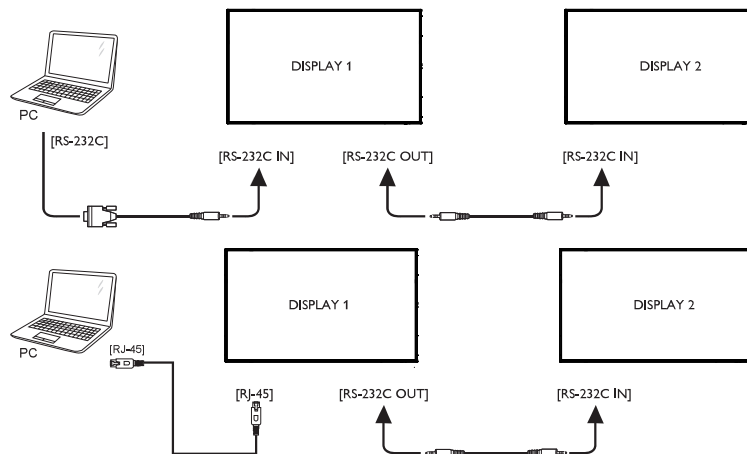

**3.5. IR connection**

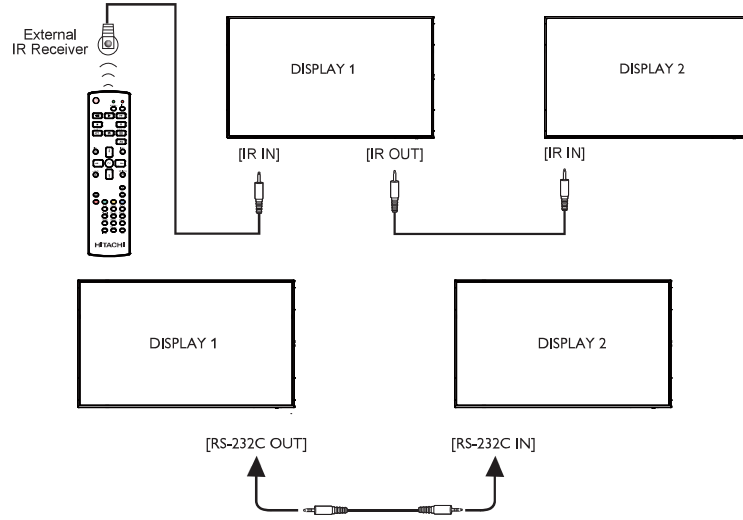

NOTE:

1. This display's remote control sensor will stop working if the [IR IN] is connected.
2. IR loop through connection can support up to 9 displays.
3. IR in daisy chain via RS232 connection can support up to 9 displays.

**3.6. IR Pass-through Connection**

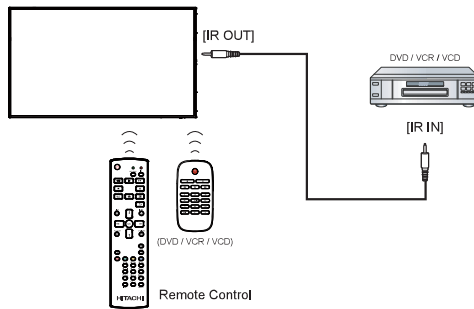

## 4. Operation

**NOTE:** The control button described in this section is mainly on the remote control unless specified otherwise.

### 4.1. Watch the Connected Video Source

1. Press **[SOURCE]** button.
2. Press **[A]** or **[I]** button to choose a device, then press **[OK]** button.

### 4.2. Change Picture Format

You can change the picture format to suit the video source. Each video source has its available picture formats.

The available picture formats depend on the video source:

1. Press **[FORMAT]** button.
  - PC mode: {Full} / {4:3} / {1:1} / {21:9} / {Custom},
  - Video mode: {Full} / {4:3} / {1:1} / {21:9} / {Custom},

### 4.3. Overview

1. Operation system launcher:
  - Operation system launcher is black page, as below:

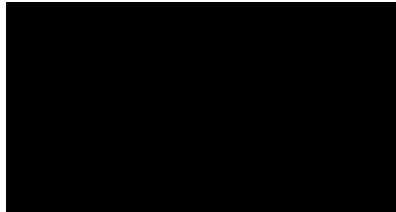

- Every apps leave by press back key, the screen will go to operation system launcher;
- When you return to operation system launcher; the screen will show hint image, the hint image only show 5 second, as below:
- The hint image will notify you can press source key to change source.



2. Admin mode:
  - You can press "Home + 1668" to enter admin mode. Please make sure you see the Home OSD menu after "Home" is pressed, and then press 1668 in sequence. Two continuous "Home" keys will not be a valid hotkey.
  - Admin mode will show four icons: "Settings", "Apps", "Network" and "Storage".
  - When you leave admin mode, system will return to last source.

1) Home page of admin mode, this page has four items: "Settings", "Apps", "Network" and "Storage".

Settings : go to settings app.

Applications : show all apps.

Network : set Ethernet and Mobile network (optional).

Storage : display current PD Operation system storage information.

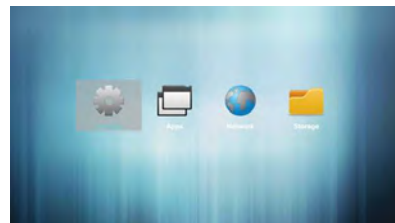

2.) Application page:

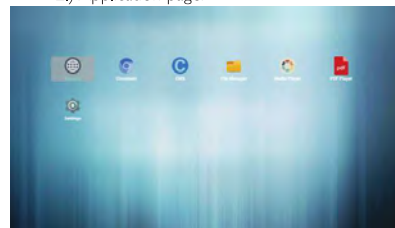

3) Network page

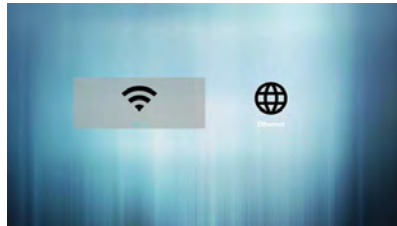

4) Ethernet page



#### 4.4. Media Player introduction:

1. Home page of MediaPlayer app, this page has three items: "Play", "Compose" and "Settings".  
Play : select playlist to play.  
Compose: edit playlist.  
Settings: setting play properties.

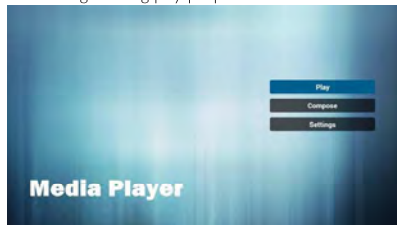

2. Select "Play" on home page, first you should choose one playlist to play between FILE 1 and FILE 7.  
The pencil icon means the playlist is non-empty.

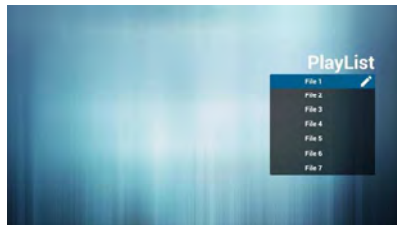

3. Select "Compose" on home page, first you should choose one playlist to edit between FILE 1 and FILE 7.  
The pencil icon means the playlist is non-empty.



4. If an empty playlist is chosen, the app will guide you to select the media source.  
All media files should be placed in /signage/ of root directory.  
For example,  
- videos in /root/signage/video/  
- photos in /root/signage/photo/  
- music in /root/signage/music/

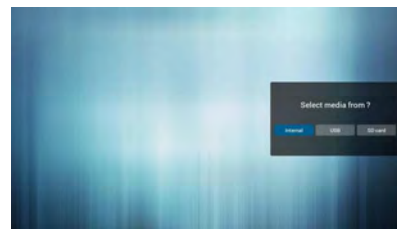

5. You could edit or delete a non-empty playlist, just choose the desired playlist which is with pencil icon.

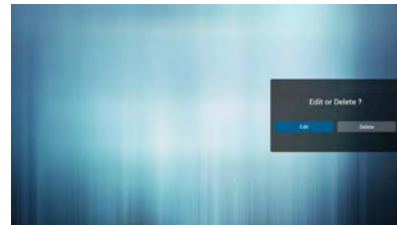

6. Once you start to edit a playlist, you will see below screen.  
Source - files in storage.  
Playlist - files in playlist.  
There are 4 icons which map to the keys of remote controller, Option key - launch slide bar  
Play key - play media file.  
Info key - show media info.  
Ok key - select/unselect file.

6-1 In the slide bar, it helps you to do the following:

- select all : select all storage files.
- delete all : delete all playlist files.
- add/remove : update playlist from source.
- sort : sort playlist.
- save/abort : save or abort playlist.

DS75MU01

- back : return.

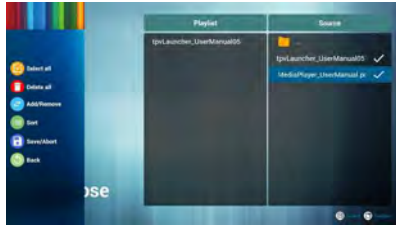

7. If you choose "Sort" in the slide bar, you can change the order of files one by one,



8. Press info key after you choose desired file, you will get the detail information,



9. Press play key after you choose desired file, you will play the media file directly,



10. If you make a playlist with all images files, before saving, the app will ask you if you want to have background music while slideshow playing,



11. Select "Settings" on home page, this page has three parts, "Repeat Mode", "Slideshow Effect" and "Effect Duration",

- Repeat Mode : play mode.
- Slideshow Effect : photo slideshow effect.
- Effect Duration : photo effect duration,

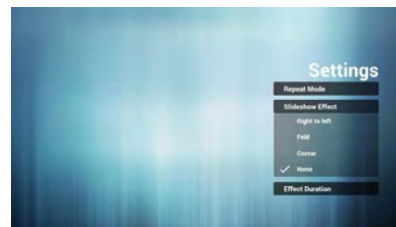

12. Media Hotkey
- Play : Playback file.
  - Pause: Pause file.
  - Fast forward: forward 20 second.
  - Rewind: back 20 second.
  - Stop: Stop file and return to start. If the gif file, it like the pause.

**4.5. Browser manual**

1. Home page of Browser app, this page has one item: "Settings". Press Settings then enter next page,



2. Users can choose 1~7. Press any one will show a dialog.

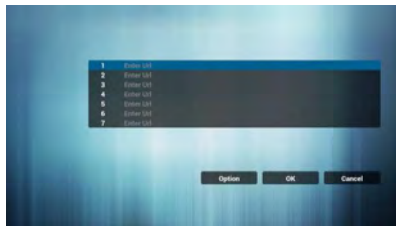

3. Enter url and press OK then data will save on List

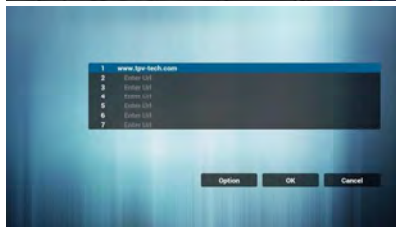

4. Press "Option" then left side will pop up a list  
 Import : Import url list file  
 Export : Export url list file  
 Delete all : Delete all url record on right side  
 Back : left side list will be closed,



4.1 Import

- Click import



- Choose storage

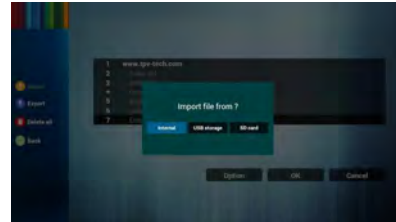

- Choose file contains url

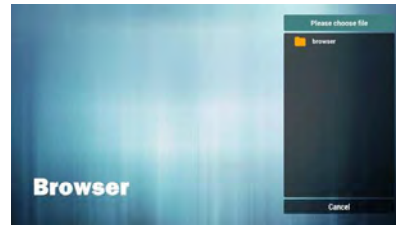

- Import file and url will show on list



- File format for import  
 Format should be like below with file extension "txt"



4.2 Export:

- Click export



DS75MU01

- Choose storage



- Dialog shows path file will be saved and file's name.  
Press "save" button then urls on list will be saved.

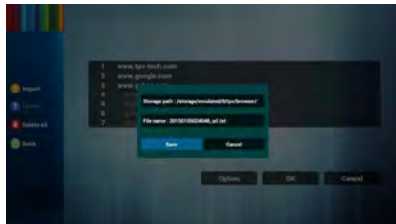

5. Press OK then url records will be saved

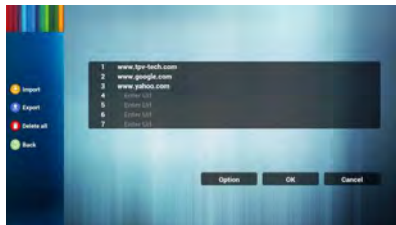

6. On url list page, if you select non-empty item, it will show a dialog to ask edit or play url. If press "Edit", it will show edit url dialog, if press "Play", it will show web page of item's url.

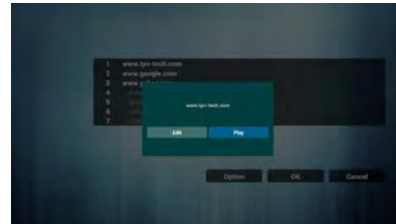

7. OSD menu interaction with Browser

7.1 Boot on source

- Set OSD menu => Configuration1 => Boot on source => Input be BROWSER Play List be 0, Then PD will show Browser after reboot,
- Set OSD menu => Configuration1 => Boot on source => Input be BROWSER Play List be 1, Then PD will show web page with 1st Url in Browser app.

7.2 Schedule

Set OSD menu => Advanced option => Schedule =>

On time1, Off time2, Input be BROWSER, any day you want of week, and Play List.

Finally check the right box.

Then PD will show web page with Url in Browser app at time1 and finish at time2.

4.6. PDF reader play

1. Home page of Pdf app, this page has three items: "Play", "Compose" and "Settings".

Play : select playlist to play.

Compose: edit playlist.

Settings: setting play properties.

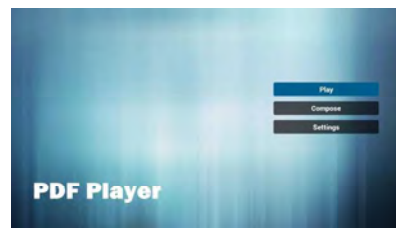

2. Select "Play" on home page, first you should choose one playlist to play between FILE 1 and FILE 7.

The pencil icon means the playlist is non-empty.

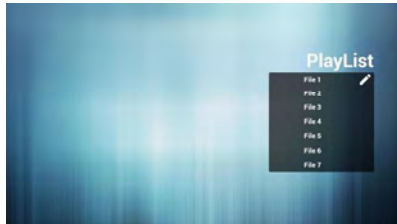

3. Select "Compose" on home page, first you should choose one playlist to edit between FILE 1 and FILE 7.

The pencil icon means the playlist is non-empty.

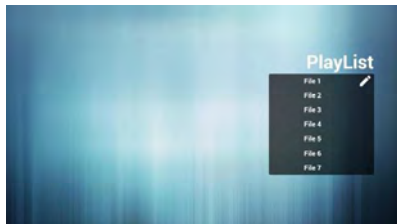

4. If an empty playlist is chosen, the app will guide you to select the media source.

All media files should be placed in /signage/ of root directory, For example,  
- pdfs in /root/signage/pdf/

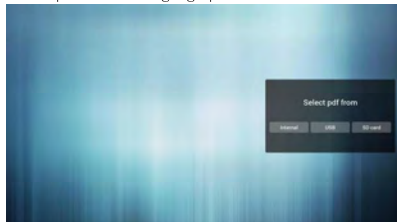

5. You could edit or delete a non-empty playlist, just choose the desired playlist which is with pencil icon.

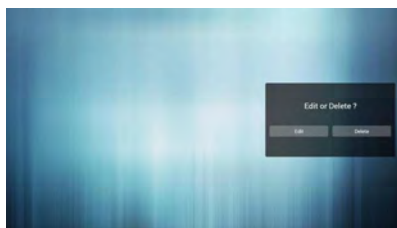

6. Once you start to edit a playlist, you will see below screen,  
Source - files in storage.

Playlist – files in playlist.

There are 4 icons which map to the keys of remote controller: Option key – launch slide bar

Play key – play media file.

Info key – show media info.

Ok key – select/unselect file.

6-1. In the slide bar, it helps you to do the following:

- select all : select all storage files.
- delete all : delete all playlist files.
- add/remove : update playlist from source.
- sort : sort playlist.
- save/abort : save or abort playlist.
- back : return.

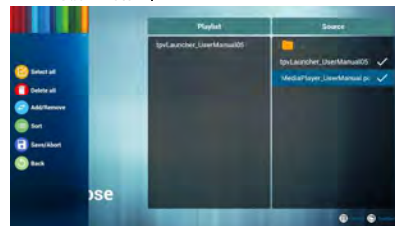

7. If you choose "Sort" in the sidebar, you can change the order of files one by one.

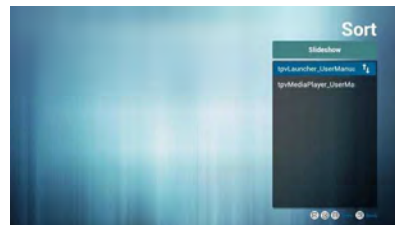

8. Select "Settings" on home page, this page has two parts, "Repeat Mode" and "Effect Duration";  
Repeat Mode : play mode,  
Effect Duration : photo effect duration.

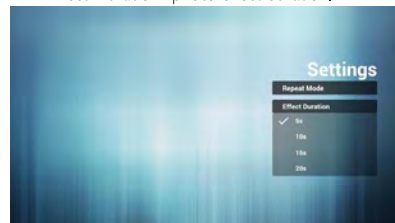

**Media Hotkey:**

Play : Playback file.



## DS75MU01

Pause: Pause page,

Fast forward: go to next page, if the page is end of the file, it will go to next file,

Rewind: back to last page, if the page is first of the file, it will back to last file.

Stop: return to first page of file

### Color Hotkey:

Blue : Zoom in,(+10%)

Yellow : Zoom out,(-10%)

OK : Restore zoom

### Arrow keys:

Up/Down/Left/Right : Adjust page, (When the page has zoomed in/out)

Left : Previous Page, (When the page has not zoomed in/out)

Right : Next Page, (When the page has not zoomed in/out)

### Combination key:

Number key + OK key : select specific page, and press ok key to change page.

- Press number key.

- Press OK key, the bottom of the page will show the page number; if page number over total page number, it will not change page and show current page number at the bottom of the page.

## 4.7. CMS

1) Server

Setup CMS server address

2) Account

Setup CMS account

3) PIN Code

Setup CMS PIN code

(4) Version

Ver.3

(5) Content

There are internal storage/SD card/USB storage 3 options for selecting,



When Ver.3, Server/Account/PIN code is available.



## 5. Signage display

### 5.1. Setting

Main items:

- (1) Ethernet
- (2) Proxy
- (3) Signage Display
- (4) System Tools
- (5) Display
- (6) Apps
- (7) Security
- (8) Date & time
- (9) Developer options
- (10) About

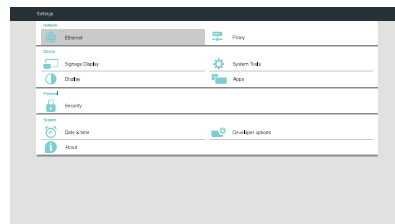

### 5.2. Ethernet

Enable/Disable to turn on/off Ethernet

After enable Ethernet, the settings will show:

- (1) Connection Type (Available connection type: DHCP/Static IP)
  - A. DHCP
  - B. Static IP
  - C. IP Address
  - D. Netmask
  - E. DNS Address
  - F. Gateway
- (2) Mac Address

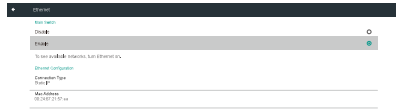

- Select an "Type". (Proxy server type.)
- Done.
  - If the proxy server is need an authentication to connect, please "check on" the Authentication and input Username & Password.
  - If the proxy server is not need an authentication to connect,

### 5.2.1. DHCP

DHCP mode:

- (1) Cannot modify IP Address, Netmask, DNS Address and Gateway.
- (2) If connect successfully, it will display current network configuration.

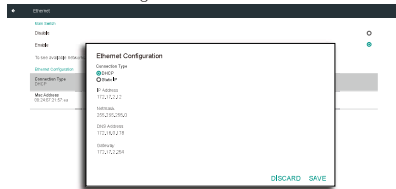

Note:

- Proxy type in HTTP,HTTPS,SOCKS4,SOCKS5 are support.
- Only support the connection through the proxy server with TCP port 80 & 443 & 5228.
- Proxy server with authentication on Windows Sever Series is not support.

### 5.2.2. Static IP

In Static IP mode, user can input IP Address, Netmask, DNS address and Gateway

Note:

IP address, netmask, DNS address and gateway address input limitation

- (1)Format:
  - I. number 0-9
  - II. decimal point "."

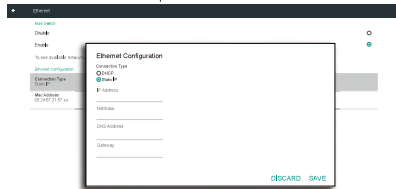

### 5.4. Signage Display

Divide into 4 groups: General Settings / Server Settings / Source Settings / Security

- (1) General Settings
  - A. Signage Display Name
  - B. Boot Logo
  - C. Screenshot
- (2) Server Settings
  - A. Email Notification
  - B. FTP
  - C. Remote Control
  - D. SSCP Network Port
- (3) Source Settings
  - A. Media Player
  - B. Browser
  - C. CMND & Play
  - D. PDF Player
  - E. Custom app
- (4) Security
  - A. External Storage
- (5) Other
  - A. TeamViewer Support
  - B. Platform Web API

### 5.3. Proxy

Browser connect to Proxy server and ask Proxy server to connect some website on Internet.

Enable/Disable to turn on/off Proxy server.

- Click "Enable" to switch proxy function "ON"
- Input the "Proxy hostname". (Proxy server IP address)
- Input the "Proxy port". (Proxy server port number)

## DS75MU01

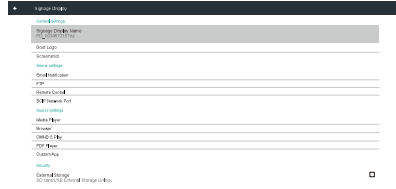

### 5.4.1. General Settings

#### 1. Signage Display Name

Set up PD name "PD\_" + Ethernet Mac Address,

Note:

Input limitation:

- (1) length: Max 36 characters
- (2) format: no limit

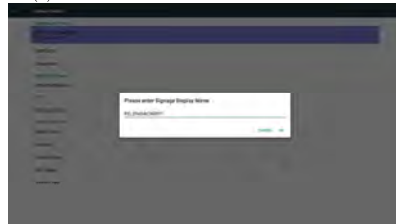

#### 2. Boot Logo

- 1) Scalar OSD menu to control system boot logo enable/disable

Scalar OSD menu operation

RCU: Home -> Configuration2 -> Logo -> On/Off/User

In user mode, user can choose their own boot logo animation file.

Note:

- (1) Boot animation file name: bootanimation.zip
- (2) Will pop-up a window for user to select USB and SD card, No priority issue.



- 2) When boot logo selected, PD will check if there is bootanimation.zip under USB and SD card.

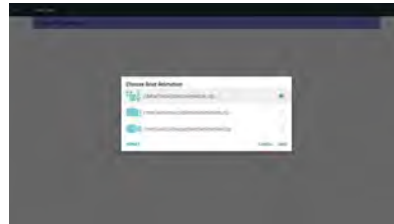

Function introduction:

- a. Option description

/data/local

Use customized boot animation file which is copied from SD card or USB

/mnt/external\_sd

Use boot animations file under SD card

/mnt/usb\_storage

Use boot animations file under USB

- b. Save

Press save key to save SD card or USB bootanimation.zip to /data/local and set it as boot logo.

- c. Forget

Press Forget key to delete /data/local bootanimation.zip and not show boot logo.

- d. Cancel

Close dialogue w/o changes.

Scenario introduction:

Case 1

The user don't settle customized boot logo, PD does not find any bootanimation.zip file under SD and USB, The list will be blank, Save and Forget button will be gray and useless.



Case 2

The users do not settle customized boot logo, PD find bootanimation.zip file under SD and USB, The screen will show bootanimation.zip and select the first file automatically.



### Case 3

The user settle customized boot logo, the screen will show /data/local/bootanimation.zip.



3) If OSD menu Logo item is On or Off, the users cannot choose boot animation in Operation system settings,

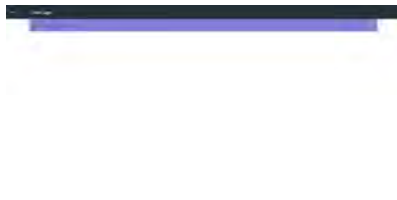

### 3. Screenshot

Via Enable/Disable to control screenshot On/Off, After Enable, user can set screenshot timeslot and save path,

Note:

Time slot of deletion and screenshot:

- (1) Will delete picture at initial time 0 sec.
- (2) Will screenshot at first 40 sec.
- (3) Media player, Browser, CMND & play, PDF reader, Custom source are supported.
- (4) Screenshot will not include video container

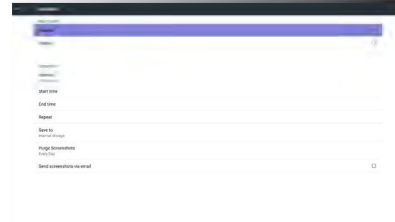

### 1) Interval

Set up interval timeframe, 30 mins or 60 mins,



### 2) Start Time

Set up screenshot start time,

Note:

- (1) If no start time, the screen will show current time automatically
- (2) Just press Back key to exit dialog for Set up
- (3) Start time cannot be newer than End time. It will show Error toast.



### 3) End Time

Set up screenshot End time

Note :

- (1) If no End time, the screen will show current time automatically
- (2) Start time cannot be newer than End time. It will show error toast,



4)Repeat  
Set up screenshot repeat cycle. User can choose screenshot time frame, (Multiple selection)



5)Save to  
Set up screenshot save path. Internal storage, SD card or USB storage.)  
Note:  
picture storage path  
(1) In root of internal storage/usb storage/sd card, PD will create folder automatically.  
(2) The picture will save to Signage/Screenshot/.

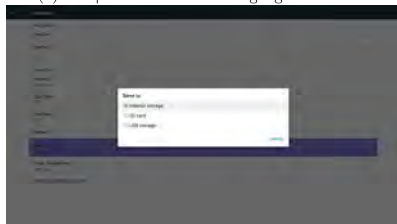

6)Purge Screenssignage  
Set up purge timeframe. One day or One week.

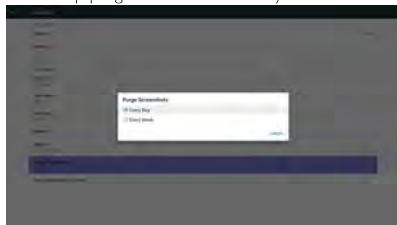

(7) Send screenshsignage via email  
After check this item, it will send screenshot to email of administrator

Please refer to 6,2,1 Email notification  
Note:  
Please confirm Email setting is done.

**5.4.2. Server Settings**

1. Email Notification  
Via Enable/Disable to control Email On/Off)  
After Enable, user can set up Email notification configuration.



1) SMTP  
Set SMTP configuration)  
User can set Gmail account or other mail account.

User can select other mail account and set up SMTP server; Security type and port item

Note  
Password input limitation  
(1) Length: 6-20 characters  
(2) Format: no limit  
(3) unavailable port: 5000





Gmail safety setting

If Gmail is not working when setting is complete, please test Gmail account via PC and link below URL

<https://www.google.com/settings/security/lesssecureapps>

And confirm "Access for less secure apps" item is Turn On



Yahoo Email Security Setting

If Yahoo Email is not working when setting complete, please confirm "Allow apps that use less secure sign in" item is enabled.



2) Manager Email

Set up Receiver mail account



3) Test

Send Test Mail

To test Gmail account receive/send function.

Note

(1) When Email is Disable, "Send Test Mail Button" button will gray out

2. FTP

Via Enable/Disable to control FTP On/Off, After set up, PD can share FTP files.

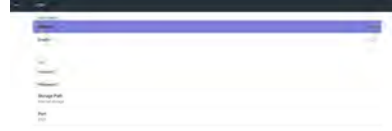

1) Account

Set up FTP account

Note:

Input limitation

- (1) Length: 4-20 characters
- (2) Format:
  - I. English a-z and A-Z
  - II. Number 0-9



2) Password

Set up FTP password.

Note:

Input limitation

- (1) Length: 6-20 characters
- (2) Format:
  - I. English a-z and A-Z
  - II. Number 0-9

FTP password display

(1) Will show "\*" symbol to instead password if set up password via remote control.

(2) After set up, the password text will show as "\*" symbol.

Before password input:

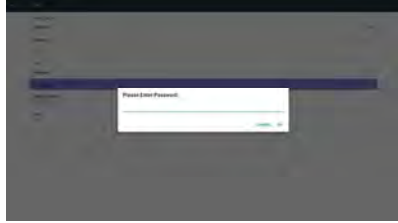

After password input:



Set up completed screen:



3)Storage Path

Show default path: Internal storage

Note:

Can only display Internal storage, cannot be modified,(Only show path)



4) Will show Server is unbinded if Remote control server feedback unbinded status.

5) Port

Set up FTP port number; Default: 2121

Note:

Input limitation

(1) Length: Max 5 characters

(2) Range: 1024 ~ 65535

(3) Format: Number 0-9

(4) Unavailable port: 5000

(5) The port number must more than 1024

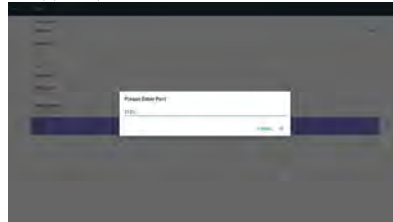

3. Remote Control

Via Enable/Disable to Control Remote Control On/Off

User can input Server address. If server does not registered, it will ask user for PIN code.

Bind status:

(1) Will show network is disconnected if not yet connects to network.

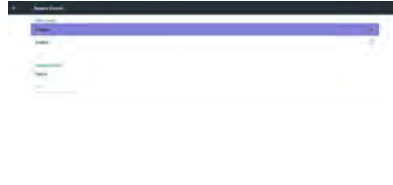

(2) Will show Server is disconnected if network connected but remote control server disconnected.



(3) Will show Server is unbinded if Remote control server feedback unbinded status.

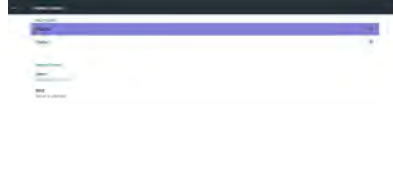

(4) Will show Server is binded if Sever binded successfully.

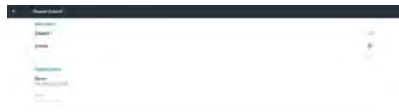

(5) Will show Error PIN code if input incorrect PIN code.



4. SICP Network Port

Change SICP Network Port.

Note:

1. Range: 1025-65535

2. unavailable port: 8000 / 9988 / 15220 / 28123 / 28124

5.4.3. Source Settings

1. Media Player

Can Edit Media Player play list and effect settings.

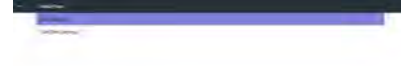

(1) Open Media Player Player List edit page.

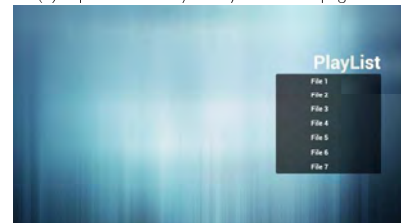

(2) Open Media Player slideshow effect edit page.

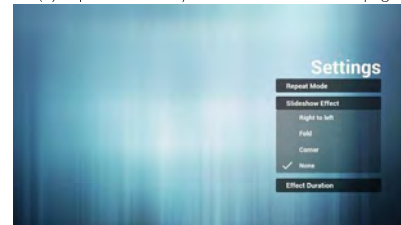

2. Browser

Can edit Bookmark configuration.

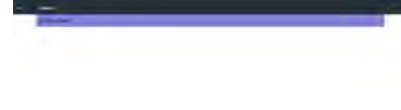

(1) Open Browser setting page.





3. CMS

- 1) Server  
Setup CMS server address
- 2) Account  
Setup CMS account
- 3) PIN Code  
Setup CMS PIN code
- (4) Version  
Ver:3
- (5) Content  
There are internal storage/SD card/USB storage 3 options for selecting



When Ver:3, Server/Account/PIN code is available.



4. PDF Player

Can edit PDF Player Play List and Effect Settings.

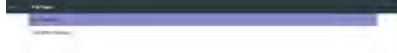

(1) Open PDF Player Player List edit page.



(2) Open PDF Player effect edit page

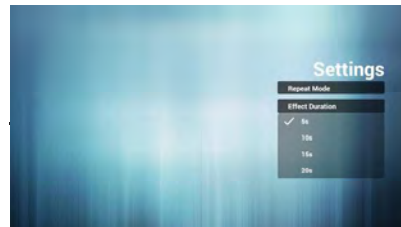

5.4.4. Security

1. External Storage

- Enable: SD card/USB External Storage Lock,
- Disable: SD card/USB External Storage Unlock,

Note:

Must re-plug SD card/USB External Storage after unlock the external storage.

5.4.5. Other

- (1) TeamViewer Support  
Enable / Disable TeamViewer support.
- (2) Platform Web API  
Enable / Disable Platform Web API.

5.5. System Tools

System tools 4 main functions:

- (1) Clear Storage
- (2) Factory Reset
- (3) Import & Export
- (4) Clone Media Files



### 5.5.1. Clear Storage

The purpose is to clear all data in Signage folders.

Divided into 4 mode:

- (1) Clear all Signage folders
- (2) Only clear Signage folder under Internal storage.
- (3) Only clear Signage folder under USB storage.
- (4) Only clear Signage folder under SD card.

Pop-up the window to display all folders which can be clear;

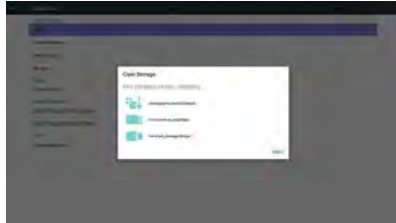

### 5.5.2. Factory Reset

Factory Reset can recover to Factory default settings.



Press OK to execute Reset function automatically.



### 5.5.3. Import & Export

The function of Import & Export PD settings.

Notes,

- (1) Settings.db (Saved file name: settings.db)
- (2) Will save to Signage folder in storage

#### 5.5.3.1 Export Signage Display Settings

Will export to Signage folder under USB or SD card

- (1) Export settings.db. Include OSD setting, Operation system settings but "Signage Display Name" and "Boot Logo"

Note:

If no Signage folder exists in USB or SD card, it will be created automatically.

List all available storage (internal/SD/USB)

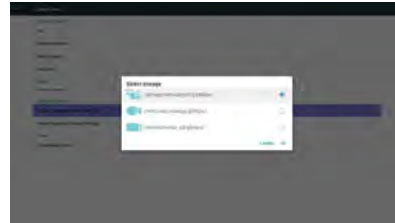

#### 5.5.3.2 Import Signage Display Settings

Import settings.db from Signage folder under USB or SD card.

- (1) Import settings.db. Include OSD setting, Operation system settings but "Signage Display Name" and "Boot Logo"

List all available storage (Internal/SD/USB)

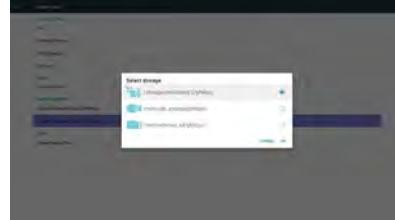

Show notification dialog before database import



### 5.6. Clone Media File

Clone media file from Internal, SD or USB Signage folder;

1. The cloned folder name under Signage folder

- (1) Signage/photo
- (2) Signage/music
- (3) Signage/video
- (4) Signage/cms
- (5) Signage/pdf
- (6) Signage/browser

2. The cloned file extension name is ".cms")

## DS75MU01

Clone Source

- (1) Internal storage
  - (a) check FTP
  - (b) check /Signage/
- (2) SD / USB

Files under root

Target Location

- (1) Internal storage
  - Save to /Signage/
- (2) SD / USB
  - Save to root



### 5.7. Display

User can modify the font size, can choose: Small/ Normal/Large/Huge



### 5.8. Apps

Display applications information.

Note

- (1) User options key on RCU to show setting option.



### 5.9. Security

- (1) Credential storage
- Control panel of certificates

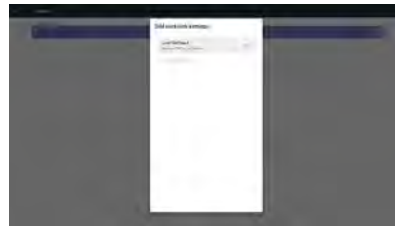

### 5.10. Date & time

Via Scalar OSD menu to control Auto Time On/Off.

Note:

Add new NTP server to display current server IP.



### 5.11. Developer options

Operation system developer options.

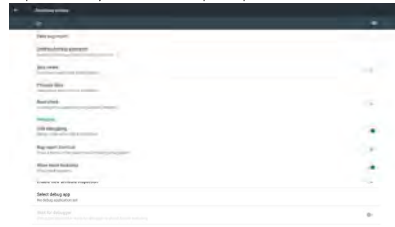

### 5.12. About

Main info in About:

- (1) System updates
- (2) System Firmware version
- (3) Kernel version
- (4) Build number

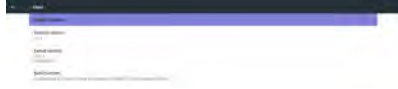

### 5.12.1. System updates

Will automatically search update.zip in USB.

Will be shown in list for user selection if found

Note:

- (1) Only support Operation system Full image.
- (2) file name should be update.zip.
- (3) the file should be located in root of storage.

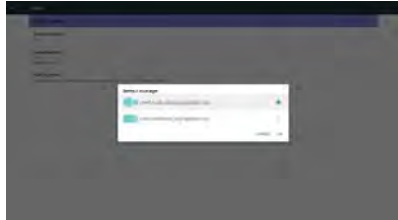

After select update.zip file, PD will restart and start to update.

## 5.13. Supplementary

### 5.13.1. Quick Info

You can press "Info + 77" to startup quick info.

Quick info will show "Network" and "Monitor Information", as below:

Note:

Operation hours : It is updated every minute.

Heat status : It is updated every 5 seconds.



### 5.13.2. How to custom an Operation system boot animation?

#### 1. Overview

The Operation system boot animation is used script to load PNG files when the device bosignage. It is

contained within an uncompressed zip file called bootanimation.zip.

#### 2. Inside the bootanimation.zip file

The bootanimation.zip as follow:

- The image folder (Contains PNG images named in incremental numbers)
- The desc.txt file

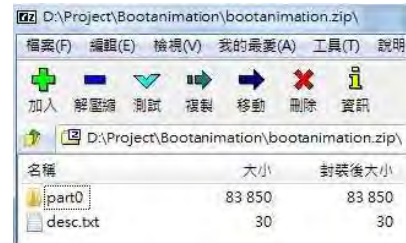

#### (1) The image folder

These contain PNG images named in numbers, starting from something like 0000.png or 0001.png and proceeding with increments of 1. There has to be at least one folder and there is no known upper limit to the number of folders.

#### (2) The desc.txt file

This file defines how the images in the folder(s) are displayed during the boot animation, in the following format:

- Width Height Frame-rate
- mode Loop delay-time Folder1
- mode Loop delay-time Folder2

An example of a desc.txt file is:

- 1920 1080 30
- p 1 0 part0
- p 0 0 part1

#### a. The first line

1920 and 1080 define the width and height of the screen resolution.

30 is the frame rate in fps (frames per second) i.e. number of images to display per second.

b. The second and third lines have a same format.

The first 'p' defines play mode is immediately stop playing when boot complete.

The number after 'p' defines repeat mode

- specifying 0 would make the part loop indefinitely till the device has boot complete.
- specifying 1 would make the part playback once.

## DS75MU01

The next number defines the delay time(ms).  
For example, if set 10, when all image files has been playback, system will delay 10ms.

The part0 and part1 are image folder name.

The above example, the boot animation will play at a resolution of 1920 by 1080 pixels, at a frame rate of 30 fps, starting with the contents of part0 folder and after playing them in one loop, switching to contents of part1 folder and playing them continuously till the device boot complete.

### 3. Zip file:

Select everything (image folders and desc.txt) inside the Bootanimation folder and zip them into a new **uncompressed zip archive** using your favorite compression utility like 7zip or WinRAR and so on.

If using 7zip, set compression level to "Store"



If using WinRAR, set "Compression method" to "Store"

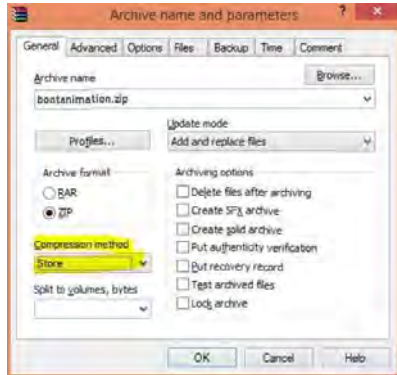

or else bootanimation WON'T work

### 4. Apply the custom bootanimation

Procedure:

- (1). Put your custom bootanimztion.zip file into external SD card or USB and plug into PD platform.
- (2.) Make sure the Logo option is enabled.

Press Home key on RCU: OSD menu -> Configuration 2 -> Logo -> set "User"

(3.) Press combination key "Home + 1888" on RCU to go to Admin mode:

Settings -> Signage Display -> GENERAL SETTINGS -> Boot Logo

(4.) The system will find the bootanimation.zip in external SD card or USB automatically and copy it to /data/local

(5.) Once step 1~4 has been done, restart the system. The new customized boot animation should be displayed during boot time.

## 6. OSD Menu

An overall view of the On-Screen Display (OSD) structure is shown below. You can use it as a reference for further adjusting your display.

### 6.1. Navigating the OSD Menu

#### 6.1.1. Navigating the OSD menu using the remote control

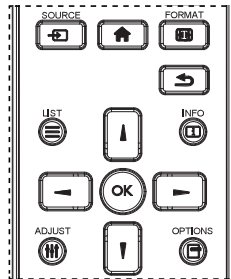

1. Press [**HOME**] button on the remote control to display the OSD menu.
2. Press [**▲**] or [**▼**] button to choose the item you want to adjust.
3. Press [**OK**] or [**▶**] button to enter the submenu.
4. In the submenu, press [**▲**] or [**▼**] button to toggle among items, press [**◀**] or [**▶**] button to adjust settings. If there is a submenu, press [**OK**] or [**▶**] button to enter the submenu.
5. Press [**↶**] button to return to the previous menu, or press [**HOME**] button to exit the OSD menu.

#### 6.1.2. Navigating the OSD menu using the display's control buttons

1. Press [**MENU**] button to display the OSD menu.
2. Press [**+**] or [**-**] button to choose the item you want to adjust.
3. Press [**+**] button to enter the submenu.
4. In the submenu, press [**▲**] or [**▼**] button to toggle among items, press [**+**] or [**-**] button to adjust settings. If there is a submenu, press [**+**] button to enter the submenu.
5. Press [**MENU**] button to return to the previous menu, or press [**MENU**] button several times to exit the OSD menu.

## 6.2. OSD Menu Overview

### 6.2.1. Picture menu

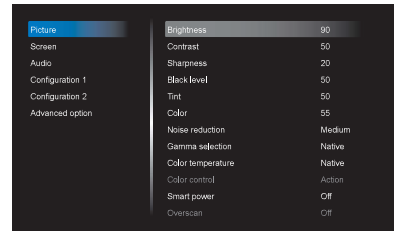

#### Brightness(Picture)

Adjust the overall image and background screen brightness(backlight).

#### Contrast

Adjust the image contrast ratio for the input signal.

#### Sharpness

This function is digitally capable to keep crisp image at any timings.

It is adjustable to get a distinct image or a soft one as you prefer and set independently for each picture mode.

#### Black level

Adjust the image brightness for the background.

NOTE: sRGB picture mode is standard and cannot be changed.

#### Tint (Hue)

Adjust the tint of the screen.

Press + button the flesh tone color becomes greenish.

Press - button the flesh tone color becomes purplish.

NOTE:VIDEO mode only.

#### Color(Saturation)

Adjust the color of the screen.

Press + button to increase color depth.

Press - button to decrease color depth.

NOTE:VIDEO mode only

#### Noise Reduction

Adjust the noise reduction level.

#### Gamma selection

Select a display gamma. It's refer to the brightness performance curve of signal input. Choose from {Native} / {2.2} / {2.4} / {s gamma} / {D-image}.

NOTE: sRGB picture mode is standard and cannot be changed.

## DS75MU01

### Color temperature

It is used to adjust the color temperature.

The image becomes reddish as the color temperature decreases, and becomes bluish as the color temperature increases.

CCT	10000° K	9300° K	7500° K	6500° K	5000° K	4000° K	3000° K
<b>X</b>	0.279 ± 0.030	0.283 ± 0.030	0.299 ± 0.030	0.313 ± 0.030	0.346 ± 0.030	0.382 ± 0.030	0.440 ± 0.030
<b>Y</b>	0.292 ± 0.030	0.298 ± 0.030	0.315 ± 0.030	0.329 ± 0.030	0.359 ± 0.030	0.384 ± 0.030	0.403 ± 0.030

### Color control

The color levels of red, green, and blue are adjusted by the color bars.

R: Red gain, G: Green gain, B: Blue gain.

### Smart power

Smart Power control is not relative to brightness control

- Initial setting Brightness  
90 (in the range from 0-100)  
Power consumption 90% of maximum power consumption
- Smart Power  
OFF: no adaptation  
MEDIUM: 80% of power consumption relative to current settings  
HIGH: 65% of power consumption relative to current settings

### Overscan

Change the display area of the image.

ON: Set to display area about 95%.

OFF: Set to display area about 100%.

### Picture reset

Reset all settings in the Picture menu.

Select "Yes" and press "SET" button to restore to factory preset data.

Press "EXIT" button to cancel and then return to the previous menu.

### 6.2.2. Screen menu

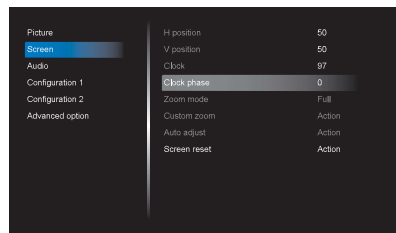

### H position

Control Horizontal Image position within the display area of the LCD.

Press + button to move screen to right.

Press - button to move screen to left.

NOTE:VGA input only.

### V position

Control Vertical Image position within the display area of the LCD.

Press + button to move screen to up.

Press - button to move screen to down.

NOTE:VGA input only.

### Clock

Press + button to expand the width of the image on the screen the right.

Press - button to narrow the width of the image on the screen the left.

NOTE:VGA input only.

### Clock phase

Adjust the focal length of the monitor. It is used to remove any horizontal interference and make the text look clear.

NOTE:VGA input only.

### Zoom mode



HDMI, DP,VGA, OPS: {Full} / {4:3} / {Real} / {21:9} / {Custom}.

Playing media in Media Player : {Full} / {4:3} / {Real} / {21:9}

There are no function when BROWSER, CMND & Play, PDF Player, PDF Player, Custom and Media Player UI and Operation system UI

Zoom Mode will be "Full" when tiling

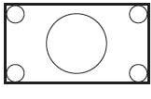



	<b>Full</b> This mode restores the correct proportions of pictures transmitted in 16:9 using the full screen display.
	<b>4:3</b> The picture is reproduced in 4:3 format and a black band is displayed on either side of the picture.
	<b>Real</b> This mode displays the image pixel-by-pixel on screen without scaling the original image size.

	<b>16:9</b> The picture is reproduced in 16:9 format and a black band at the top and bottom.
	<b>21:9</b> The picture is reproduced in 21:9 format and a black band at the top and bottom.
	<b>Custom</b> Choose to apply the custom zoom settings in the Custom Zoom submenu.

**Custom zoom**

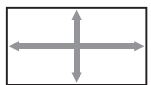
You can use this function to further customize the zoom settings to suit the image you want to display.

NOTE: This item is functional only when the {Zoom mode} is set to {Custom}.

	<b>Zoom</b> Expands the horizontal and vertical sizes of the image simultaneously.
	<b>H zoom</b> Expands the horizontal size of the image only.
	<b>V zoom</b> Expands the vertical size of the image only.
	<b>H position</b> Moves the horizontal position of the image left or right.
	<b>V position</b> Moves the vertical position of the image up or down.

**Auto adjust**

Press "Set" to detect and adjust H position, V position, Clock, Phase automatically.

NOTE:VGA input only.

**Screen reset**

Reset all settings in the Screen menu to factory preset values.

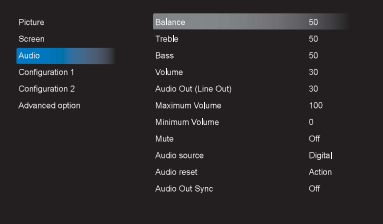
**6.2.3. Audio menu**

Picture	Balance	50
Screen	Treble	50
Audio	Bass	50
Configuration 1	Volume	30
Configuration 2	Audio Out (Line Out)	30
Advanced option	Maximum Volume	100
	Minimum Volume	0
	Mute	Off
	Audio source	Digital
	Audio reset	Action
	Audio Out Sync	Off

**Balance**

Adjust to emphasize left or right audio output balance.

**Treble**

Adjust to increase or decrease higher-pitched sounds.

**Bass**

Adjust to increase or decrease lower-pitched sounds.

**Volume**

Adjust to increase or decrease the audio output level.

**Audio out (line out)**

Adjust to increase or decrease line out output level.

**Maximum volume**

Adjust your own limitation for the maximum volume setting. This stops the volume from being playing at too loud a level.

**Minimum volume**

Adjust your own limitation for the minimum volume setting.

**Mute**

Turn the mute function on/off.

**Audio source**

Select the audio input source. There are no audio output when no video signal.

Analog: audio from audio input

Digital: audio from HDMI audio.

**Audio reset**

Reset all settings in the Audio menu to factory preset values.

**Audio Out Sync**

Enable/disable audio out (line out) volume adjustability to sync with internal speakers.



### 6.2.4. Configuration1 menu

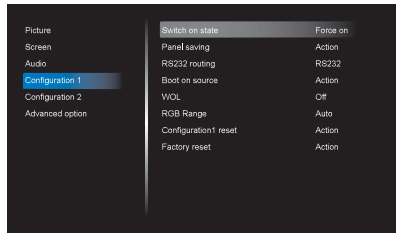

#### Switch on state

Select the display status used for the next time you connect the power cord,

- **{Power off}** - The display will remain off when the power cord is connected to a wall outlet.
- **{Forced on}** - The display will turn on when the power cord is connected to a wall outlet.
- **{Last status}** - The display will return to the previous power status (on/off/standby) when removing and replacing the power cord.

#### Panel saving

Choose to enable the panel saving functions and thus reduce the risk of

"image persistence" or "ghost-imaging".

- **{Brightness}** - Select **{On}** and the image brightness will be reduced to an appropriate level. The Brightness setting in the Picture menu will be unavailable when selected.
- **{Pixel shift}** - Select the time interval (**{Auto}** / **{10 ~ 900}** Seconds / **{Off}**) for the display to slightly expand the image size and shift the position of pixels in four directions (up, down, left, or right).

Note: Only support external input source (HDMI,VGA, DP,OPS),

#### RS232 Routing

Select the network control port.

Choose from: **{RS232}** / **{LAN -> RS232}** / **{CardOPSR232 (OPS model only)}**.

#### Boot on source

Choose to select source when boot up.

Input: select input source when boot up.

Playlist: select playlist index for Media player, Browser, PDF player;

0: no play list. Same as switch source from OSD.1~7: playlist number.

No failover function, system will keep source even the source is no signal input.

#### WOL

Choose to turn on or off the wake on LAN function,

Choose from : **{Off}** / **{ On}**

#### RGB Range

Manual correction gray-scale color.

#### Configuration1 reset

Reset all settings in **Configuration1** menu to the factory preset values,

#### Factory reset

Reset all settings in the OSD menus of **{Picture}**, **{Screen}**, **{Audio}**, **{Configuration1}**, **{Configuration2}**, and **{Advanced option}** to the factory preset values.

Operation system settings will also reset when factory reset.

Press **[←]** or **[→]** button to select **{Reset}**, and press **[OK]** button to do the reset.



### 6.2.5. Configuration2 menu

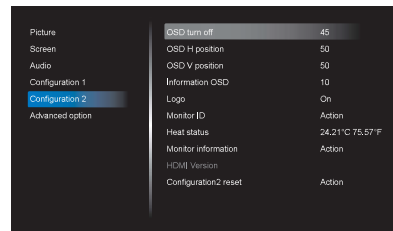

#### OSD turn off

Set the period of time the OSD (on-screen display) menu stays on the screen.

The options are: **{Off}**, **5 ~ 120** seconds.

\***{Off}** does not disappear automatically.

#### OSD H position

Adjust the horizontal position of the OSD menu.

#### OSD V position

Adjust the vertical position of the OSD menu.

#### Information OSD

Set the period of time the information OSD is displayed on the upper right corner of the screen. The information OSD will display when input signal is changed.

The information OSD will remain on the screen with **{Off}** selection.

The options are: **{1 ~ 60}** seconds.

## Logo

Choose to enable or disable the picture of Logo when turn on your display.

The options are:

- {Off}
  - {On} (Default)
  - {User}
1. If Logo set to ON, both scalar Signage logo and Operation system animation Signage logo will show.
  2. If Log set to OFF, neither scalar Signage logo nor Operation system animation logo will not show.
  3. If Logo set to USER, custom logo option in Operation system is not set, then there will be no boot logo when power on.
  4. If Logo set to USER, custom logo option in Operation system is set, there will be only custom logo when power up.

\* Logo will NOT rotate with rotation setting/ detection.

## Monitor ID

Set the ID number for controlling the display via the RS232C connection. Each display must have a unique ID number when multiple sets of this display are connected, Monitor ID number range is between 1 to 255.

The option are: {Monitor group}

Monitor ID	
Monitor ID	1
Monitor group	1

- {Monitor group}
  - The options are: {Off} / {1-254}
  - {Off} – {Monitor group} are not supported.
  - {1-254} – {Monitor group} are supported. The default setting is 1.

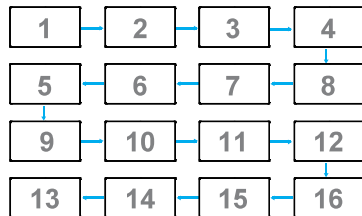

## Heat status

This function allows you to check the thermal status at any time.

## Monitor information

Shows information about your display, including model number, serial number, operating hours and software version.

Monitor information	
Model name	DS75MU01
Serial NO.	N/A
Operation hours	0
SW Version	FB01.06

## HDMI Version

Set the HDMI version to 1,4 or 2,0, this setting is only valid on HDMI input

## Configuration2 reset

Reset all settings in Configuration2 menu to the factory preset values.

### 6.2.6. Advanced option menu

Picture	IR control	Unlock
Screen	Power LED Light	On
Audio	Keyboard control	Unlock
Configuration 1	Off Timer	Off
Configuration 2	Date and time	Action
Advanced option	Schedule	Action
	HDMI with One Wire	Off
	Language	English
	OSD Transparency	Off
	Power Save	Mode 1
	Advanced option reset	Action

## IR control

Select the operation mode of the remote control when multiple displays are connected via an RS232C connection.

- {Unlock} - All displays can be operated normally by the remote control unit.
- {Primary} - Designate this display as the primary display for remote control operation. Only this display can be operated by the remote control. (In primary mode, IR key will always be processed regardless the monitor id/group settings).
- {Secondary} - Designate this display as the secondary display. This display can not be operated by the remote control, and will only receive the control signal from the primary display via the RS232C connection.
- {Lock All} / {Lock all but Volume} / {Lock all but Power} / {Lock all except PWR & VOL}- Lock the remote control function of this display. To unlock, press and hold the **[i]** INFO button on the remote control for 6 (six) seconds.

## Power LED light

Choose to set power indicate LED on or off.

## DS75MU01

Choose {On} for normal use.

### Keyboard control

Choose to enable or disable the display keyboard (control buttons) function.

- {Unlock} - Enable the keyboard function.
- {Lock All} / {Lock all but Volume} / {Lock all but Power} / {Lock all except PWR & VOL} - Disable the keyboard function.

NOTE: "Keyboard Control Lock Mode" This function completely disables the access to all Keyboard Control functions. To enable or disable the keyboard control lock, press both [+] and [V] buttons and hold down continuously for more than 3 seconds.

### Off Timer

Set automatically power off time (in hours).

### Date and time

Adjust the current date and time for the display's internal clock.

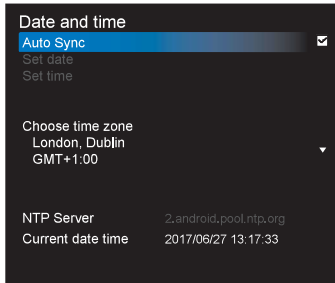

1. Press [OK] button to enter or choose
2. Press [←] back button to return.
3. Press [▲] or [▼] button to adjust them.

\* Cannot set time to date after year 2037.

### Schedule

This function allows you to program up to 7 (seven) different scheduled time intervals for the display to activate.

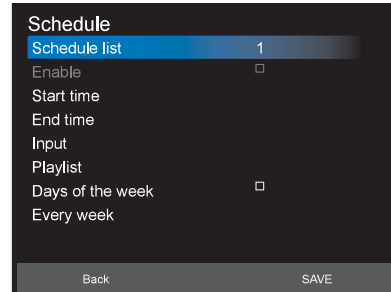

- **Schedule list:** You can set 7 schedules.
- **Enable:** Enable/disable schedule. If set start/end time is conflict or empty, input is empty or time conflict with other schedule list, you cannot enable schedule.
- **Start time:** Set start time.
- **End time:** Set end time.
- **Input:** Platform will go to this select source automatically after the schedule on.
- **Play list:** 1 - 7 : playback File1 - File7 of playlist automatically, only media player, pdf player and browser can set.
- **Days of the week:** Set Sunday, Monday, Tuesday, Wednesday, Thursday, Friday, Saturday.
- **Every week:** Set lifecycle.
- **Back:** Does not change schedule data.
- **Save:** Save schedule data.

### HDMI with One Wire

CEC control.

- {Off} - Disable CEC. (Default)
- {On} - Enable CEC.

### Language

Select the language used in the OSD menu.

The options are: English/Deutsch/ 简体中文 /Français/ Italiano/Español/Русский/PolSKI/Türkçe/ 繁體中文 / 日本語 /Português/ العربية /Danish/Svenska/Finnish/ Norsk/Nederlands.

### OSD Transparency

Adjust OSD transparency.

- {Off} - Transparency off.
- {1-100} - Transparency level 1-100.

**Power Save**

Mode 1 [TCP off,WOL on, auto off]

Mode 2 [TCP off,WOL on, auto on/off]

Mode 3 [TCP on,WOL off, auto on/off]

Mode 4 [TCP on,WOL off, no auto on/off]

Power save modes

Mode 1: DC off -> Power off, LED: Red,

Mode 3: DC off -> Back light off, LED: Red

Mode 4: DC off -> Back light off, LED: Red

Power Save -> Will not enter power save mode.  
show "no signal" only.

	RCU Power Button Off	No Signal	WoL	Operation system (ARM-T)
Mode 1 [TCP off, WOL on, auto off]	DC OFF	DC OFF	V	ARM OFF
Mode 2 [TCP off, WOL on, auto on/off] (gary out)	DC OFF	When signal is back system wake up	V	ARM OFF
Mode 3 [TCP off, WOL off, auto on/off]	Backlight OFF	Backlight OFF	X	ARM OFF
Mode 4 [TCP off, WOL off, no auto on/off]	Backlight OFF	Backlight ON, show no signal	X	ARM OFF

\*This product does not support Mode 2

Following table is the action for Operation system board with different power mode.

DC off/on: press power button by RC

Power mode in OSD	Mode 1/2	Mode 3/4
DC off	shutdown	1. The current source APK(such as MediaPlayer, Broswer, PDF or SmartCMS) will be closed. 2. Operation system system will go to the default black launcher.
DC on	Boot up	1. Operation system system reboisnagne

**Advanced option reset**

Reset all settings except {Date and Time} in the **Advanced option** menu to factory preset values.

1. Press [OK] or [▶] button to enter the submenu.
2. Press [◀] or [▶] button to select {Reset} and press the [OK] button to restore settings to factory preset values.
3. Press the [↶] button or select {Cancel} and press the [OK] button to cancel and then return to the previous menu.

## 7. Supported Media Formats

### USB Multimedia Codec Formats

Video Decode						
Type	Video Codec	Container	Decode	Encode	Channel	Remark
MPEG1/2	MPEG1/2	MPEG program stream (.DAT, .VOB, .MPG, .MPEG) MPEG transport stream (.ts, .trp) MP4 (.mp4, .mov) AVI (.avi) MKV (.mkv)	√			Max Resolution: 1080P@60fps Max Bit Rats : 40Mbps
MPEG-4	MPEG4	MP4 (.mp4, .mov) AVI (.avi) MKV (.mkv)	√			Max Resolution: 1080P@60fps Max Bit Rats : 40Mbps
H.263	H.263	FLV (.flv) AVI (.avi)	√			Max Resolution: 1080P@60fps Max Bit Rats : 40Mbps
H.264	H.264	FLV (.flv) MP4 (.mp4, .mov) MPEG transport stream (.ts, .trp) ASF (.asf) WMV (.wmv) AVI (.avi) MKV (.mkv)	√			Max Resolution: 1080P@60fps Max Bit Rats : 135Mbps 4k2k@30fps
H.265	H.265	MP4 (.mp4, .mov) MPEG transport stream (.ts, .trp) MKV (.mkv)	√			Max Resolution: 4K2K@60fps Max Bit Rats : 100Mbps
GOOGLE VP8	VP8	MKV (.mkv) WebM (.webm)	√			Max Resolution: 1080P@30fps Max Bit Rats : 20Mbps
Motion JPEG	MJPEG	AVI (.avi) MP4 (.mp4, .mov) MKV (.mkv)				Max Resolution: 1920*1080 @30fps Max Bit Rats : 40Mbps

**Audio Decode**

Type	Audio Codec	Container	Decode	Encode	Channel	Remark
MPEG Audio	MPEG1/2/2.5 Audio Layer1/2/3	MP3	V		2	Bit Rate: 8kbps~320Kbps Sampling Rate: 16KHZ~48KHz
Windows Media Audio	WMA Version 7, 8, 9,10 pro M0, 10Pro M1,M10 Pro M2	Decode: WMA	V		2	Bit Rate: 8kbps~768Kbps Sampling Rate: 8KHZ~96(M10)KHz Non-support LBR
AAC Audio	MAIN,ADIF ,ATDS Header AAC-LC and AAC-HE	File Format: AAC, M4A	V		5.1	Bit Rate: N/A Sampling Rate: 8KHZ~48KHz

**Image Decode**

Type	Image Codec	Photo	Decode	Encode	Channel	Remark
JPEG	JFIF file format 1,02	File Format: JPG, JPEG	V			Max Resolution: 7000 × 7000 The limitation of max resolution depends on DRAM
BMP	BMP	File Format: BMP	V			Max Resolution: 15360 × 8640 The limitation of max resolution depends on DRAM
PNG	PNG	File Format: PNG	V			Max Resolution: 15360 × 8640 The limitation of max resolution depends on DRAM

## NOTES:

- Sound or video may not work if the contents have a standard bit rate/frame rate above the compatible Frame/sec listed in the table above.
- Video content with a Bit rate or Frame rate larger than the rate specified in the table above can cause choppy video during playback.

## 8. Input Mode

### VGA Resolution:

Standard Resolution	Active Resolution		Refresh Rate	Pixel Rate	Aspect Ratio	Stand for Mode
	H Pixels	V Lines				
VGA	640	480	60 Hz	25,175 MHz	4:3	Video Graphic Array
			72 Hz	31,5 MHz		
			75 Hz	31,5 MHz		
WVGA	720	400	70 Hz	33,75 MHz	16:9	Wide Video Graphic Array
SVGA	800	600	60 Hz	40 MHz	4:3	Super VGA
			75 Hz	49,5 MHz		
XGA	1024	768	60 Hz	65 MHz	4:3	Extended Graphic Array
			75 Hz	78,75 MHz		
WXGA	1280	768	60 Hz	79,5 MHz	5:3	Wide XGA
WXGA	1280	800	60 Hz	79,5 MHz	16:10	Wide XGA
SXGA	1280	1024	60 Hz	108 MHz	5:4	Super XGA
WXGA	1360	768	60 Hz	85,5 MHz	16:9	Wide XGA
HD1080	1920	1080	60 Hz	148,5 MHz	16:9	HD1080

Note: 1280x768/60Hz can be supported but not shown in EDID table.

### SD Resolution:

Standard Resolution	Active Resolution		Refresh Rate	Pixel Rate	Aspect Ratio
	H Pixels	V Lines			
480i	720	480	29,97 Hz	13,5 MHz	4:3
480p			59,94 Hz	27 MHz	
576i	720	576	25 Hz	13,5 MHz	4:3
576p			50 Hz	27 MHz	

### HD Resolution:

Standard Resolution	Active Resolution		Refresh Rate	Pixel Rate	Aspect Ratio
	H Pixels	V Lines			
720p	1280	720	50 Hz	74,25 MHz	16:9
			60 Hz		
1080i	1920	1080	25 Hz	74,25 MHz	16:9
			30 Hz		
1080p	1920	1080	50 Hz	148,5 MHz	16:9
			60 Hz		
2160p (HDMI only)	3840	2160	30 Hz	297 MHz	16:9
			50 Hz		
			60 Hz		

Note: OPS/DisplayPort support 3840x2160@30Hz.

- The PC text quality is optimum in HD 1080 mode (1920 × 1080, 60Hz).
- Your PC display screen might appear different depending on the manufacturer (and your particular version of Windows).
- Check your PC instruction book for information about connecting your PC to a display.
- If a vertical and horizontal frequency-select mode exists, select 60Hz (vertical) and 31,5KHz (horizontal). In some cases, abnormal signals (such as stripes) might appear on the screen when the PC power is turned off (or if the PC is disconnected). If so, press the **[INPUT]** button to enter the video mode. Also, make sure that the PC is connected.

- When horizontal synchronous signals seem irregular in RGB mode, check PC power saving mode or cable connections.
- The display settings table complies to the IBM/VESA standards, and based on the analog input.
- The DVI support mode is regarded as same to the PC support mode.
- The best timing for the vertical frequency to each mode is 60Hz.



## **9. Cleaning and Troubleshooting**

### **9.1. Cleaning**

#### **Caution When Using the Display**

- Do not bring your hands, face or objects close to the ventilation holes of the display. The top of the display is usually very hot due to the high temperature of exhaust air being released through the ventilation holes. Burns or personal injuries may occur if any body parts are brought too close. Placing any object near the top of the display could also result in heat related damage to the object as well as the display itself.
- Be sure to disconnect all cables before moving the display. Moving the display with its cables attached may damage the cables and thus cause fire or electric shock.
- Disconnect the power plug from the wall outlet as a safety precaution before carrying out any type of cleaning or maintenance procedure.

#### **Front Panel Cleaning Instructions**

- The front of the display has been specially treated. Wipe the surface gently using only a cleaning cloth or a soft, lint-free cloth.
- If the surface becomes dirty, soak a soft, lint-free cloth in a mild detergent solution. Wring the cloth to remove excess liquid. Wipe the surface of the display to remove dirt. Then use a dry cloth of the same type to dry.
- Do not scratch or hit the surface of the panel with fingers or hard objects of any kind.
- Do not use volatile substances such as insect sprays, solvents and thinners.

#### **Cabinet Cleaning Instructions**

- If the cabinet becomes dirty, wipe the cabinet with a soft, dry cloth.
- If the cabinet is extremely dirty, soak a lint-free cloth in a mild detergent solution. Wring the cloth to remove as much moisture as possible. Wipe the cabinet. Use another dry cloth to wipe over until the surface is dry.
- Do not allow any water or detergent to come into contact with the surface of the display. If water or moisture gets inside the unit, operating problems, electrical and shock hazards may result.
- Do not scratch or hit the cabinet with fingers or hard objects of any kind.
- Do not use volatile substances such as insect sprays, solvents and thinners on the cabinet.
- Do not place anything made from rubber or PVC near the cabinet for any extended periods of time.

## 9.2. Troubleshooting

Symptom	Possible Cause	Remedy
No picture is displayed	<ol style="list-style-type: none"> <li>1. The power cord is disconnected.</li> <li>2. The main power switch on the back of the display is not switched on.</li> <li>3. The selected input has no connection.</li> <li>4. The display is in standby mode.</li> </ol>	<ol style="list-style-type: none"> <li>1. Plug in the power cord.</li> <li>2. Make sure the power switch is switched on.</li> <li>3. Connect a signal connection to the display.</li> </ol>
Interference displayed on the display or audible noise is heard	Caused by surrounding electrical appliances or fluorescent lights.	Move the display to another location to see if the interference is reduced.
Color is abnormal	The signal cable is not connected properly.	Make sure that the signal cable is attached firmly to the back of the display.
Picture is distorted with abnormal patterns	<ol style="list-style-type: none"> <li>1. The signal cable is not connected properly.</li> <li>2. The input signal is beyond the capabilities of the display.</li> </ol>	<ol style="list-style-type: none"> <li>1. Make sure that the signal cable is attached firmly.</li> <li>2. Check the video signal source to see if it is beyond the range of the display. Please verify its specifications with this display's specification section.</li> </ol>
Display image doesn't fill up the full size of the screen	<ol style="list-style-type: none"> <li>1. The zoom mode is not set correctly.</li> <li>2. Scan Mode may be set incorrectly to underscan.</li> <li>3. If the image exceeds the screen size, Scan Mode may need to be set to Underscan.</li> </ol>	Use the Zoom mode or Custom zoom function in the Screen menu to fine tune display geometry and time frequency parameter.
Can hear sound, but no picture	Improperly connected source signal cable.	Make sure that both video inputs and sound inputs are correctly connected.
Can see picture but no sound is heard	<ol style="list-style-type: none"> <li>1. Improperly connected source signal cable.</li> <li>2. Volume is turned all the way down.</li> <li>3. (Mute) is turned on.</li> <li>4. No external speaker connected.</li> </ol>	<ol style="list-style-type: none"> <li>1. Make sure that both video inputs and sound inputs are correctly connected.</li> <li>2. Press <b>[+]</b> or <b>[-]</b> button to hear sound.</li> <li>3. Switch MUTE off by using the  button.</li> <li>4. Connect external speakers and adjust the volume to a suitable level.</li> </ol>

DS75MU01

<p>Some picture elements do not light up</p>	<p>Some pixels of the display may not turn on,</p>	<p>This display is manufactured using an extremely high level of precision technology; however, sometimes some pixels of the display may not display. This is not a malfunction.</p>
<p>After-Images can still be seen on the display after the display is powered off. (Examples of still pictures include logos, video games, computer images, and images displayed in 4:3 normal mode)</p>	<p>A still picture is displayed for an over extended period of time</p>	<p>Do not allow a still image to be displayed for an extended period of time as this can cause a permanent after-image to remain on the display.</p>
<p>How to setup the settings in the menu to control all the monitors at the same time and individually via RC?</p>	<p>Daisy chained by RS232 and no IR cable</p>	<p>1, The first display sets as "Primary" on OSD (Advanced option/IR control item), others set as "Secondary".                  2, The setup OSD will show on Top-Left of display, (Toggle MENU will show again if it disappear)                  3, Default setting: ID NO: 0, GP NO: 0, this setting can control all displays by IR.                  The "+", "-" can change "ID NO" to control signal display by "Monitor ID".                  The "UP", "DOWN" can change "GP NO" to control multi-display by "Group ID".                  *The first display always be controlled by IR.</p>
<p>How is the RC working?</p>	<p>Daisy chain : no RS232 connected and IR cable</p>	<p>No need setting, just to connect with IR cables and control by IR.                  *This way has out-of-synchronism phenomenon. Suggest to use above setting with RS-232 cable.</p>

## 10. Technical Specifications

### Display:

Item	Specifications
Screen Size (Active Area)	189,27 cm / 74,52 inches
Aspect Ratio	16:9
Number of pixels	3840 (H) × 2160 (V)
Pixel pitch	0,429 (H) × 0,429 (V) [mm]
Displayable colors	10 bits(D), 1,07 Billion colors
Brightness (typical)	410 cd/m <sup>2</sup>
Contrast ratio (typical)	1200:1
Viewing angle	178 degrees

### In/Out Terminals:

Item		Specifications
Speaker Output	Internal Speakers	10W (L) + 10W (R) [RMS]/8Ω 1 Way 1 Speaker System 82 dB/W/M/160 Hz ~ 13 KHz
Audio Output	RCA R/L × 1	0,5V [rms] (Normal) / 2 Channel (L+R)
Audio Input	3,5mm phone jack × 1	0,5V [rms] (Normal) / 2 Channel (L+R)
RS232C	2,5mm Phone jack × 2	RS232C in/RS232C out
RJ-45	RJ-45 Jack × 1 (8 pin)	10/100 LAN Port
HDMI Input	HDMI Jack × 4 (Type A) (19 pin)	Digital RGB:TMDs (Video + Audio) MAX: Video - 720p, 1080p, 3840 × 2160/60 Hz Audio - 48 KHz/ 2 Channel (L+R) Supports LPCM only
VGA Input	D-SUB jack (15pin)	Digital RGB:TMDs (Video) Analog RGB: 0,7V [p-p] (75Ω), H/CS/V:TTL (2,2kΩ), MAX: 1920 × 1080/60 Hz (WUXGA)
Displayport in	Displayport Jack × 1 (20 pin)	Digital RGB:TMDs (Video + Audio) MAX: Video - 720p, 1080p, 3840 × 2160/30 Hz Audio - 48 KHz / 2 Channel (L+R) Supports LPCM only
IR Input/Output	3,5mm × 2	IR pass through or IR daisy chain
USB Input	USB × 4 (Type A)	USB 2,0 × 2, Multimedia play and service port / USB 3,0 × 1, Multimedia play only / UBS 5V / 2A × 1

**DS75MU01****General:**

Item	Specifications
Power Input	100 - 240V~, 50 - 60Hz, 5A
Power Consumption (Max)	360 W
Power Consumption (typ.)	220 W
Power Consumption (Standby & Off)	<0,5 W
Dimensions (Without Stand) [W x H x D]	1676,6 x 955,0 x 73,8 mm
Weight (Without Stand)	53,3 Kg
Gross Weight (Without Stand)	66,39 Kg

**Environmental Condition:**

Item		Specifications
Temperature	Operational	0 ~ 40°C
	Storage	-20 ~ 60°C
Humidity	Operational	20 ~ 80% RH (No condensation)
	Storage	5 ~ 95% RH (No condensation)
Altitude	Operational	0 ~ 3,000 m
	Storage / Shipment	0 ~ 9,000 m

**Internal Speaker:**

Item	Specifications
Type	1 Way 1 Speaker
Input	10 W (RMS)
Impedance	8Ω
Output Sound Pressure	82 dB/W/M
Frequency Response	160 Hz ~ 13 KHz





 **Hitachi Global Life Solutions, Inc.**



Q41G75M177901A